



Goodrich Global
SINCE 1983



zinttra®
ACOUSTIC SOLUTIONS



Zintra Baffles Ridge in Cobalt

Corruption and Crime Commission WA Office
Designed by: Sph Architecture & Interiors
Photographed by: D-Max Photography



OVERVIEW	4
BENEFITS	8
ZINTRA SHEETS	10
COLOURS	11
DIGITAL PRINT	12

BENEFITS



ETCH	18
LAYERS	22
BOX TILE	26
PATTERNS	30
SLIDING SCREENS	38
FLOOR TO CEILING	42
TEXTURES	46
BLADES	50

WALLS



QUARTER	56
BOX BAFFLES	60
BAFFLE SYSTEMS	64
INDIVIDUAL BAFFLE	68
CONNECT	72
CLOUDS	76
SHAPES	80

CEILING



CONCERTINA	86
DESK WRAP	90
DESK DIVIDERS	94
DESK SCREENS	98
DESK MODESTY	102

ACCESSORIES



HARDWARE	106
----------	-----

HARDWARE



ZINTRA OVERVIEW





Zintra Shapes in 12mm

Ulverstone High School
Designed by Philip Lighton Architects
Photography c/- Philip Lighton Architects

ZINTRA ACOUSTIC SOLUTIONS



ZINTRA IS THE IDEAL MATERIAL FOR ABSORBING INTERNAL AND EXTERNAL SOUNDS TO REDUCE THE NOISE LEVEL IN A SPACE. AVAILABLE IN A WIDE RANGE OF COLOURS AND DESIGNS, ZINTRA CAN BE USED FOR A VARIETY OF APPLICATIONS AT AN AFFORDABLE PRICE.

THE STANDARD PRODUCT LINE OFFERS COUNTLESS COMBINATIONS OF ACOUSTIC SOLUTIONS SURE TO DELIVER ON STYLE AND FUNCTION.

WHAT ARE THE **BENEFITS** OF ADDING AN **ACOUSTIC SOLUTION** TO YOUR SPACE?



1 REDUCE ECHOS,
BACKGROUND
NOISE AND
REVERBERATIONS



2 IMPROVE
SOUND QUALITY
FOR CLEAR
CONVERSATIONS



3 IMPROVE THE
PEACEFULNESS
OF YOUR ROOM



4 IMPROVE THE
AESTHETICS OF
YOUR SPACE

WHAT IS AN **NRC RATING**?

NRC IS SHORT FOR **NOISE REDUCTION COEFFICIENT** AND IS A
MEASUREMENT OF HOW MUCH SOUND A SURFACE ABSORBS

AN ACOUSTIC SOLUTION'S PERFORMANCE IS MEASURED USING THIS RATING

NRC RATINGS RANGE FROM



A **ZERO RATING** MEANS A
MATERIAL **ABSORBS 0%** OF THE
SOUND ENERGY THAT REACHES
THE MATERIAL.
REFLECTS 100% BACK.

A **1.0 RATING** MEANS A
MATERIAL **ABSORBS 100%** OF
SOUND ENERGY THAT REACHES
THE MATERIAL.
REFLECTS 0% BACK.

ZINTRA BENEFITS

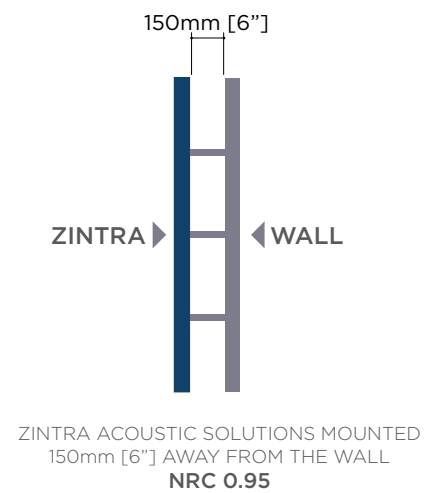
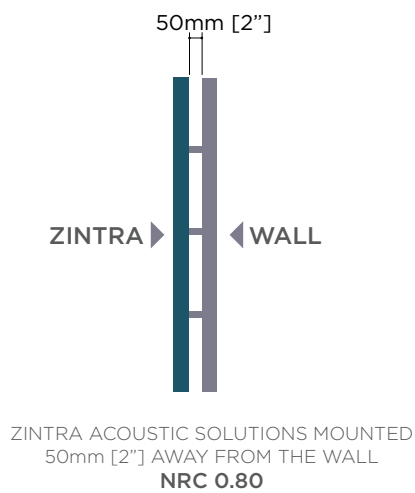
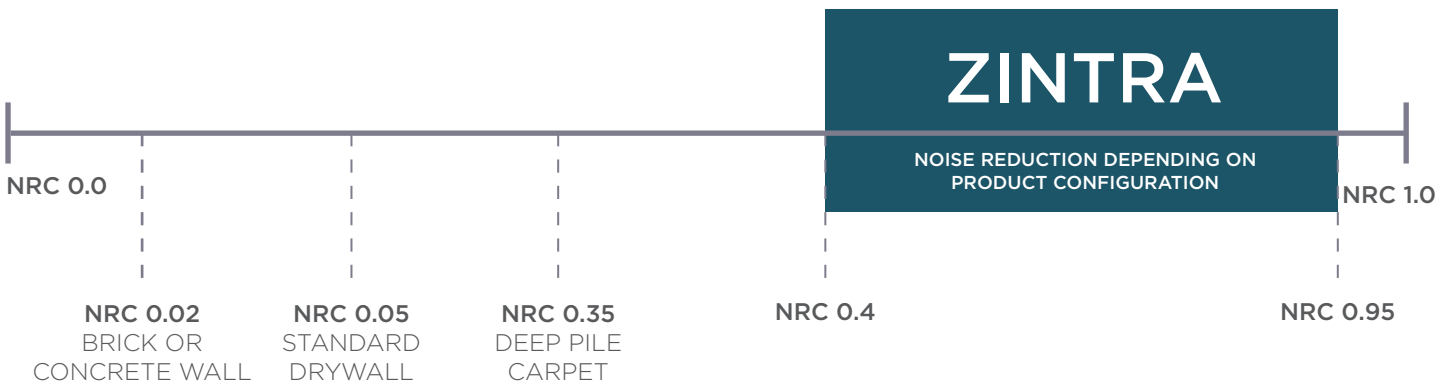



Zintra 12mm [1/2"] Sheet Colours

ZINTRA SHEETS



Zintra 12mm [1/2"] Sheet in Malachite

IDEAL FOR WALLS, CEILINGS, SCREENS, PARTITIONS AND MILLWORK. 12MM AND 24MM [1/2" AND 1"] SHEETS ARE EASILY FABRICATED AND INSTALLED TO OFFER THE SIMPLEST ACOUSTIC SOLUTION. LARGE 2800MM X 1225MM [9' X 4'] ARE EASILY CUT TO SIZE.

12MM [1/2"] COLOUR OPTIONS:



24MM [1"] COLOUR OPTIONS:





Zintra Digital Print custom image

ZINTRA DIGITAL PRINT



Zintra Digital Print custom image

COMBINE THE PERFORMANCE OF A COST EFFECTIVE AND SOUND ABSORBING SOLUTION WITH DIGITAL PRINTING TO CREATE YOUR DESIGN VISION. IDEAL FOR REINFORCING BRANDING, WAY-FINDING AND CORPORATE IDENTITY.



Zintra Digital Print custom image

DIGITAL PRINT SPECIFICATIONS

DIMENSIONS	2745mm x 1220mm x 12mm or 24mm [108" x 48" x 1/2" or 1"]
COLOURS	Available in all Zintra 12mm and 24mm [1/2" and 1"] Sheet colours. See page 11.
NRC RATING	0.45 - 0.95. See pages 8-9.
NOTES	Custom sizes available. Digital Print available on Zintra 12mm [1/2"] and 24mm [1"] sheets





Zintra Digital Print custom image



Zintra Digital Print custom image



ZINTRA WALLS



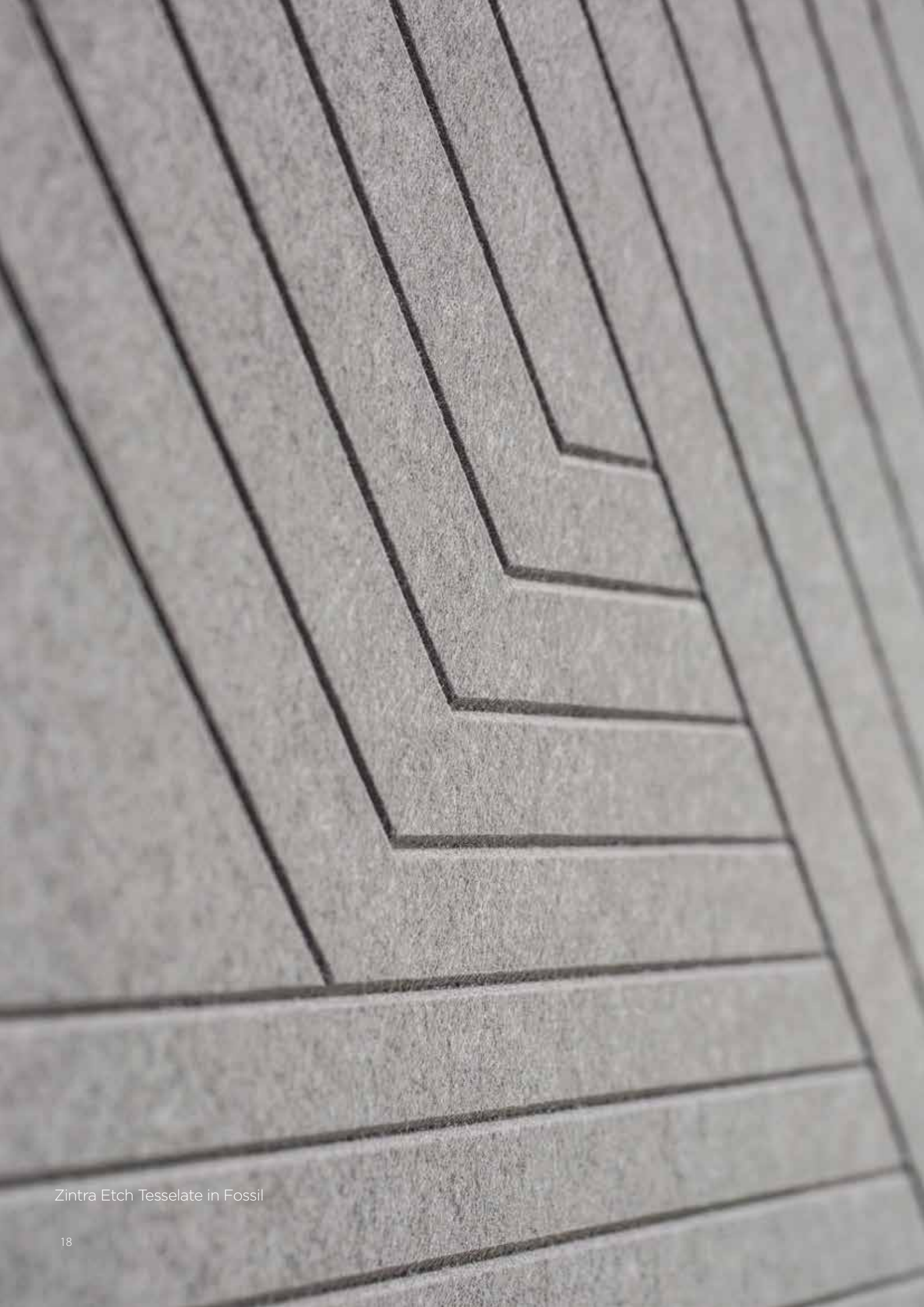

Zintra Etch Tessellate in Fossil

ZINTRA ETCH



Zintra Etch Tetris in Ecrú

ACOUSTIC ABSORPTION MEETS DYNAMIC 3D DESIGN WITH A RANGE OF SUBTLE ETCHED PATTERNS. USING A SHALLOW V-GROOVE CUT, EACH ETCH PATTERN DELIVERS A DISTINCTIVE LOOK TO WALLS OR CEILINGS.

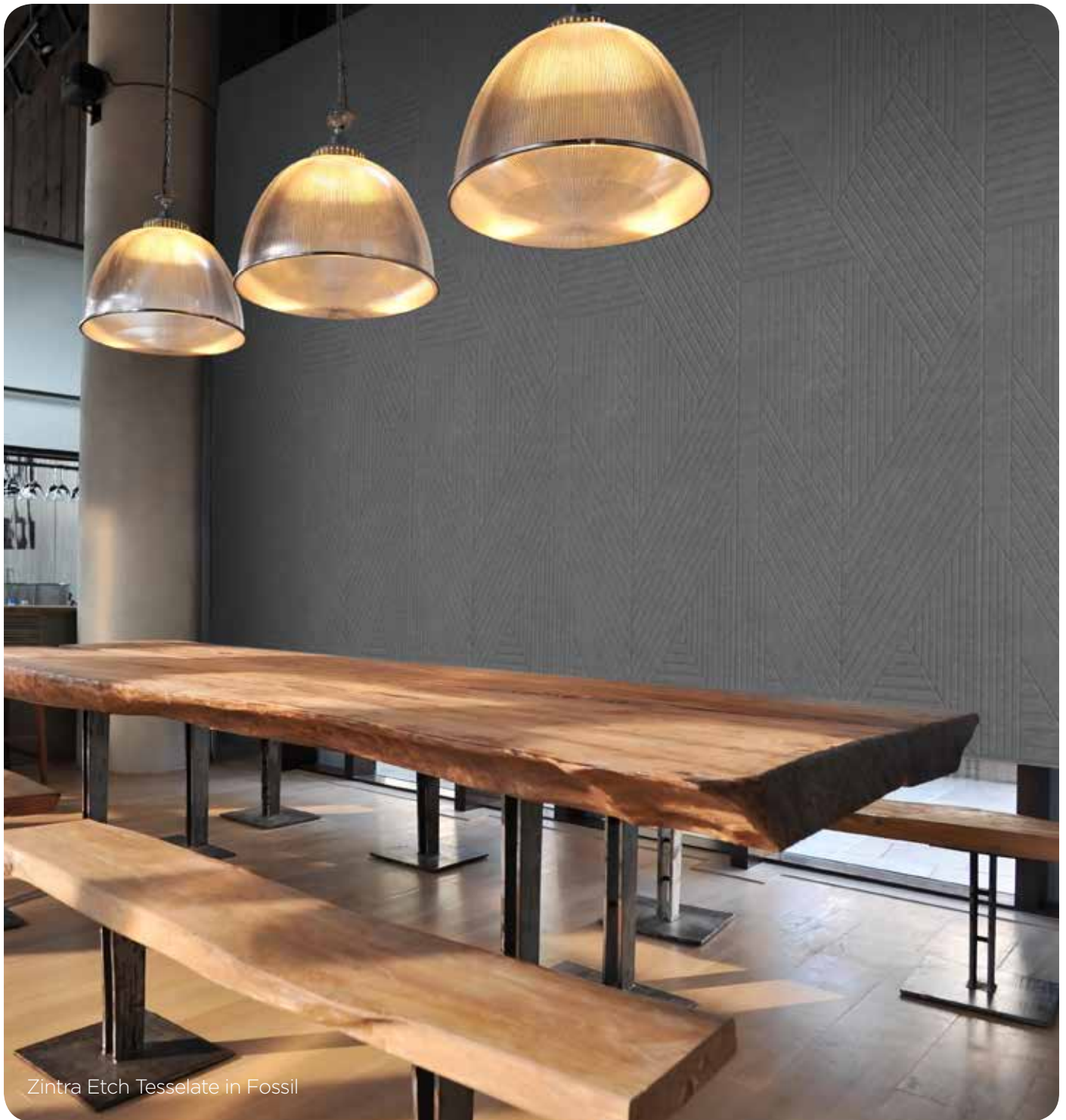

Zintra Etch Tessellate in Fossil

ETCH SPECIFICATIONS

DIMENSIONS	2745mm x 1220mm x 12mm [108" x 48" x 1/2"]
COLOURS	Available in all twenty Zintra 12mm [1/2"] Sheet colours. See page 11.
NRC RATING	0.45 - 0.95. See pages 8-9.
NOTES	Custom sizes available. For complete specification and installation information, visit baresque.com.au/brand/zintra

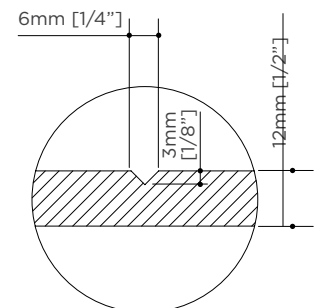

V-GROOVE DETAIL VIEW



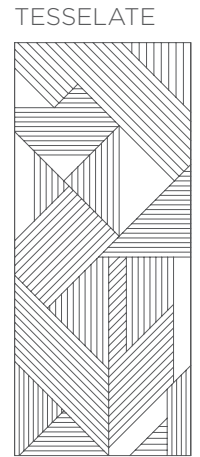
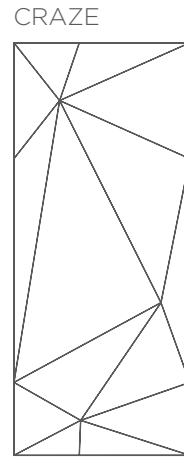
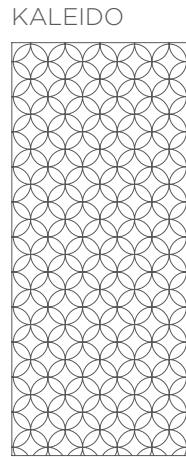
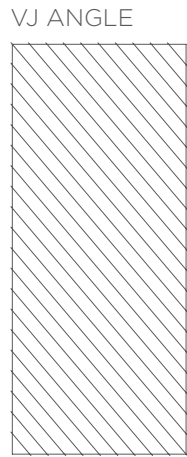
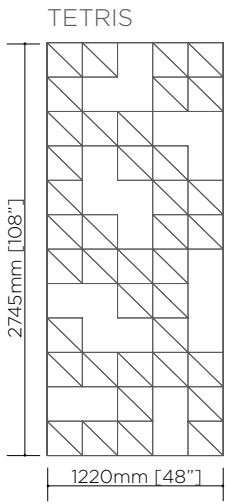

REED BED

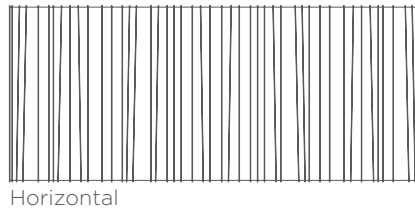
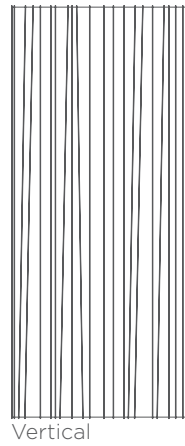

VJ BOARD NARROW

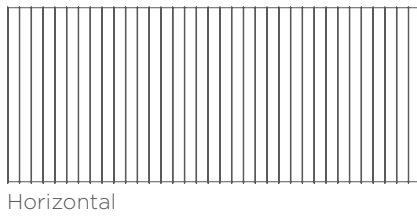
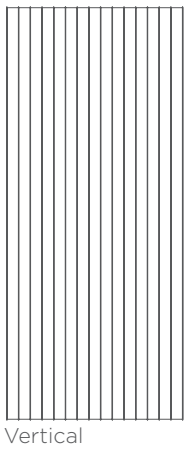

VJ BOARD WIDE

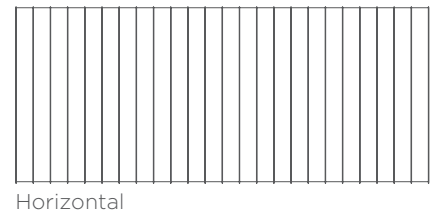
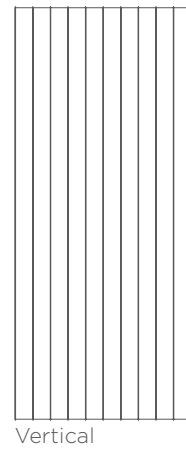



ZINTRA LAYERS



Zintra Layers in Frost, Greige and Fossil

CAREFULLY LAYERED STRIPS OF ZINTRA CREATE A VIVID STRIPED PATTERN ON THESE PANELS. CHOOSE ZINTRA 3D LAYERS IN MULTIPLE STRIP HEIGHTS FOR ADDED TEXTURE AND DEPTH. SELECT MULTIPLE COLOURS FOR A DRAMATIC EFFECT OR ONE COLOUR FOR A MORE SUBDUED VARIATION.

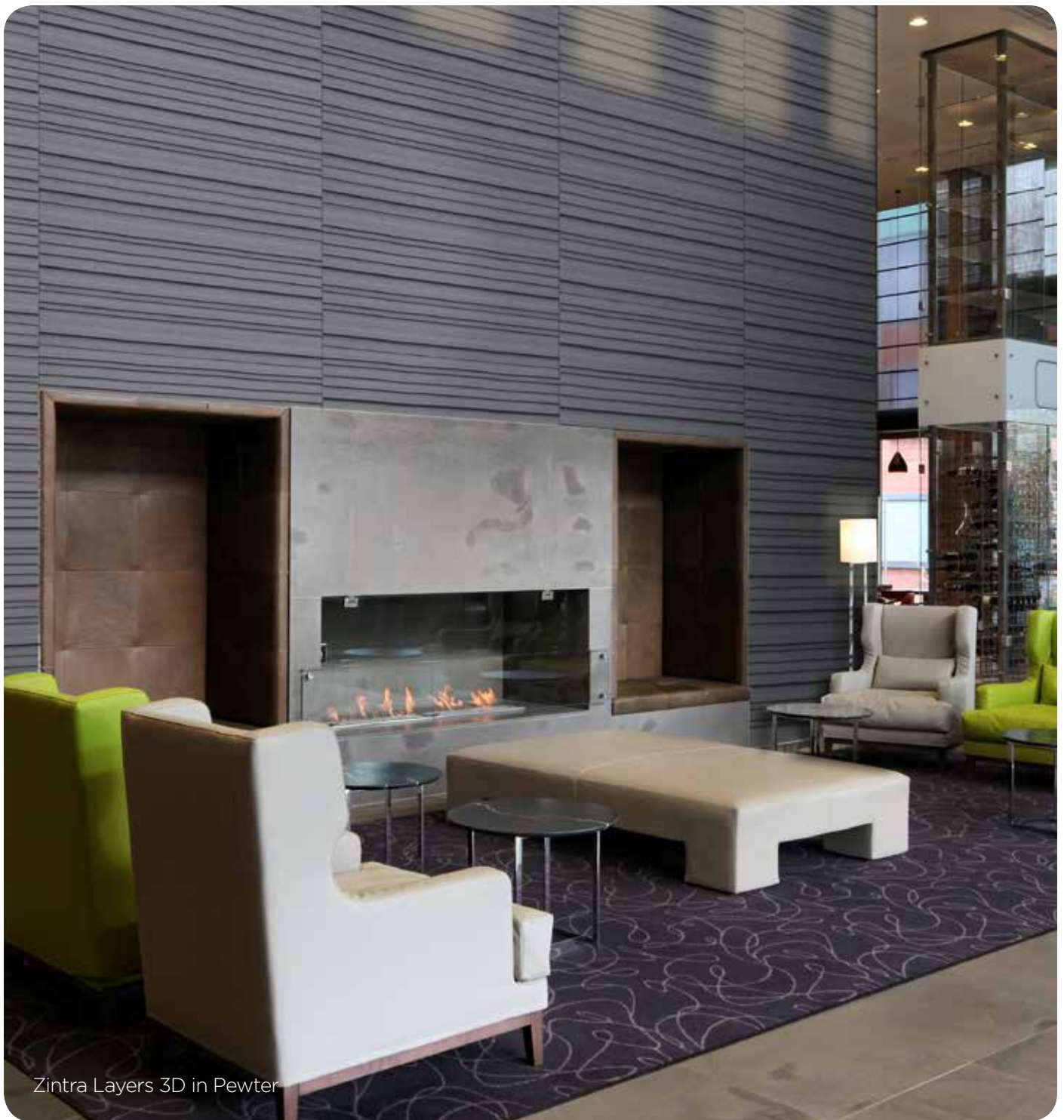

Zintra Layers 3D in Pewter

LAYERS SPECIFICATIONS

DIMENSIONS	LAYERS	2745mm x 1220mm x 24mm [108" x 48" x 1"]
	LAYERS 3D	2745mm x 1220mm x 48mm [108" x 48" x 2"]
COLOURS	Available in all twenty Zintra 12mm [1/2"] Sheet colours. See page 11.	
NRC RATING	0.75. See pages 8-9.	
NOTES	Custom sizes available. For complete specification and installation information, visit baresque.com.au/brand/zintra	



LAYERS 3D

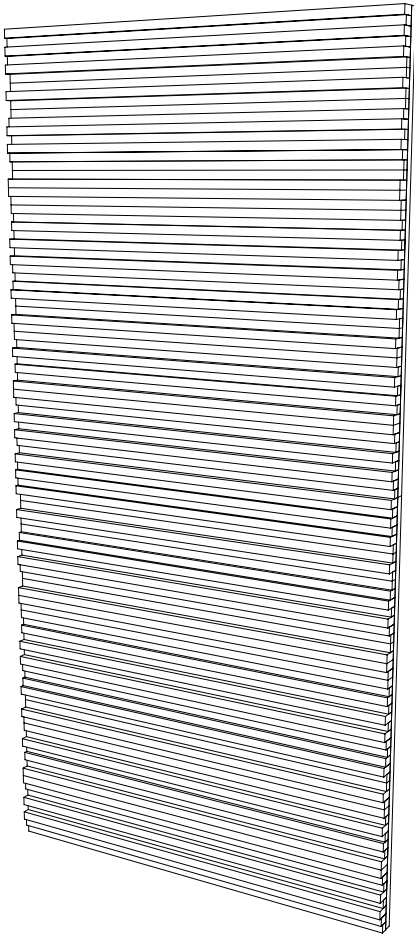

LAYERS

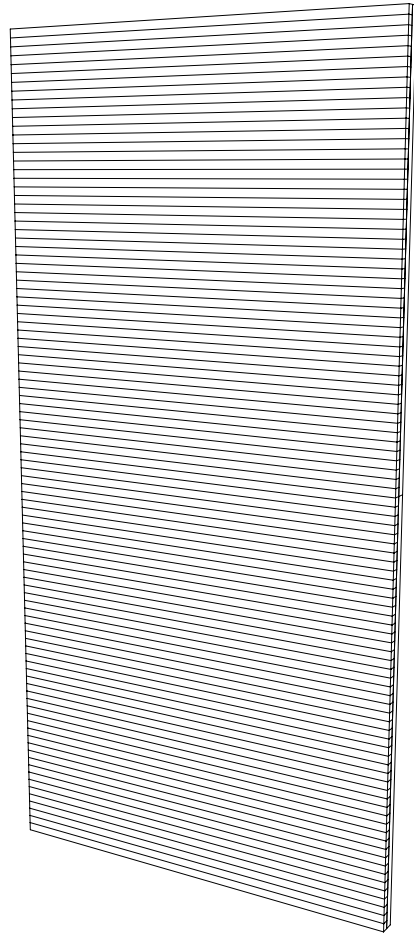



Zintra Box Tiles in Linen, Sky and Cobalt

ZINTRA BOX TILE

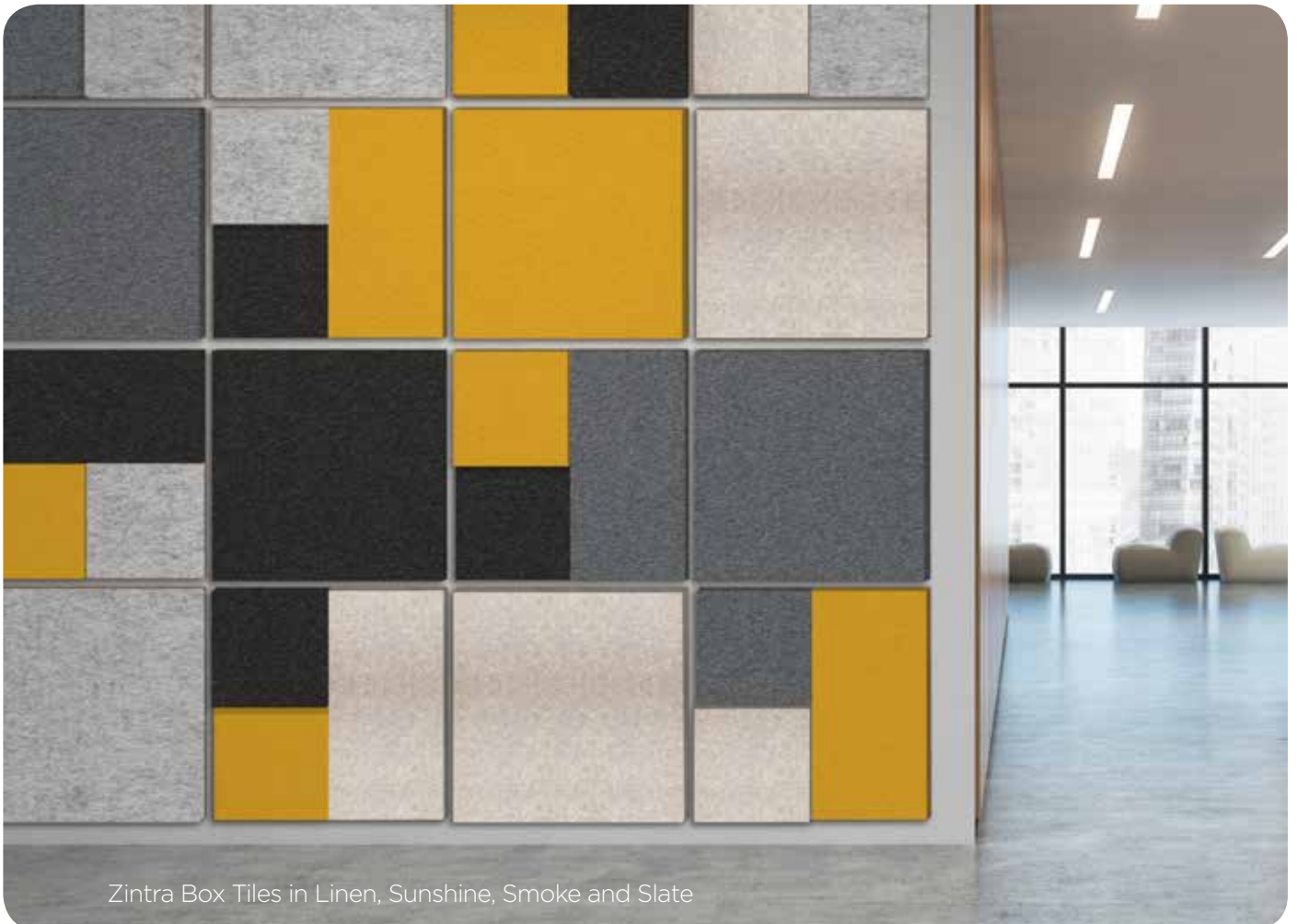

Zintra Box Tiles in Linen, Sunshine, Smoke and Slate

WITH A RANGE OF STANDARD BOX TILE SIZES AND DEPTHS, YOU CAN GIVE YOUR WALLS DIMENSION AND COLOUR WHILE ADDING THE ACOUSTIC BENEFITS OF ZINTRA. EASY TO LAYOUT, MIX AND MATCH AND INSTALL, BOX TILES ARE A GREAT ADDITION TO ANY WALL.



Zintra Box Tiles in Ivory, Smoke, Pewter and Fossil

BOX TILES SPECIFICATIONS

DIMENSIONS	SMALL	250mm x 250mm [9.8" x 9.8"]
	MEDIUM	500mm x 250mm [19.5" x 9.8"]
	LARGE	500mm x 500mm [19.5" x 19.5"]
DEPTH	LOW	12mm [1/2"]
	MID	30mm [1.2"]
	HIGH	50mm [2"]
COLOURS	Available in all twenty Zintra 12mm [1/2"] Sheet colours. See page 11.	
NRC RATING	0.45 - 0.95. See pages 8-9.	
NOTES	Custom sizes and Digital Print available.	
	Each tile is supplied with a dual lock fastener screwed into the back.	
	For complete specification and installation information, visit baresque.com.au/brand/zintra	



SUGGESTED CONFIGURATIONS

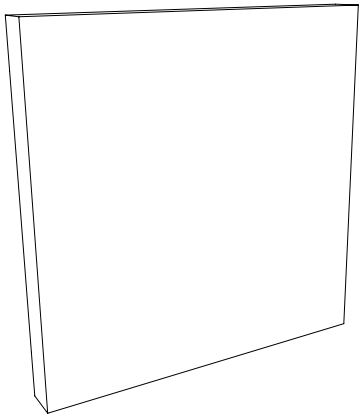

ONE LARGE

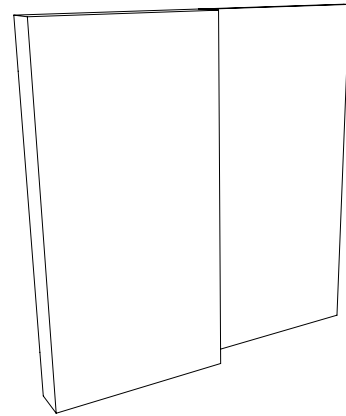

TWO MEDIUM

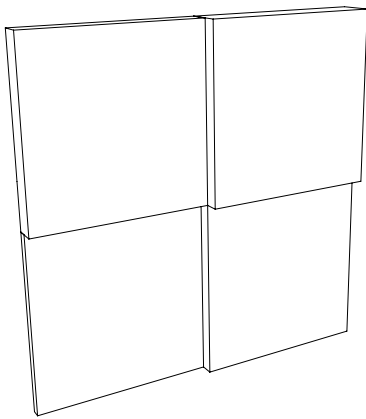

FOUR SMALL

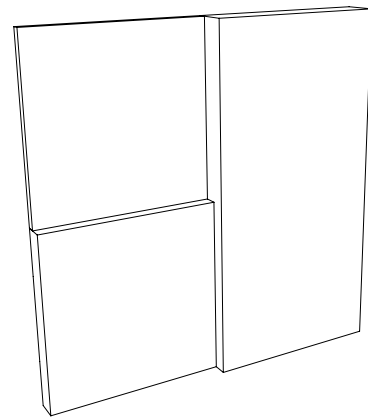

TWO SMALL + ONE MEDIUM

SMALL

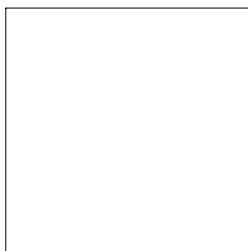

250mm x 250mm [9.8" x 9.8"]

MEDIUM



500mm x 250mm [19.5" x 9.8"]

LARGE

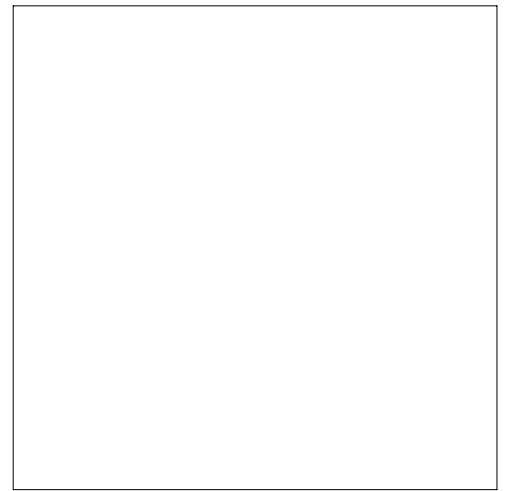

500mm x 500mm [19.5" x 19.5"]



Zintra Pattern Lost in Frost on Frost backer

ZINTRA PATTERNS



Zintra Pattern Sutra in Fossil on Linen backer

ZINTRA PATTERNS OFFER VIRTUALLY UNLIMITED STYLE OPTIONS TO WALLS, DIVIDERS AND CEILINGS. PATTERNS CAN ALSO BE PAIRED WITH A SOLID ZINTRA BACKING PANEL TO ADD EVEN MORE COLOUR, DEPTH AND TEXTURE WHILE ALSO INCREASING THE NRC VALUE.



Zintra Pattern Pixel in Linen on Cocoa backer

PATTERNS SPECIFICATIONS

DIMENSIONS	610mm x 610mm [24" x 24"] 1220mm x 610mm [48" x 24"] 2745mm x 1220mm [108" x 48"]
THICKNESS	12mm [1/2"] - Pattern layer only 24mm [1"] - Pattern layer on Backer
COLOURS	Available in all twenty Zintra 12mm [1/2"] Sheet colours. See page 11.
NRC RATING	0.45 - 0.95. See pages 8-9.
NOTES	Custom sizes available. For complete specification and installation information, visit baresque.com.au/brand/zintra



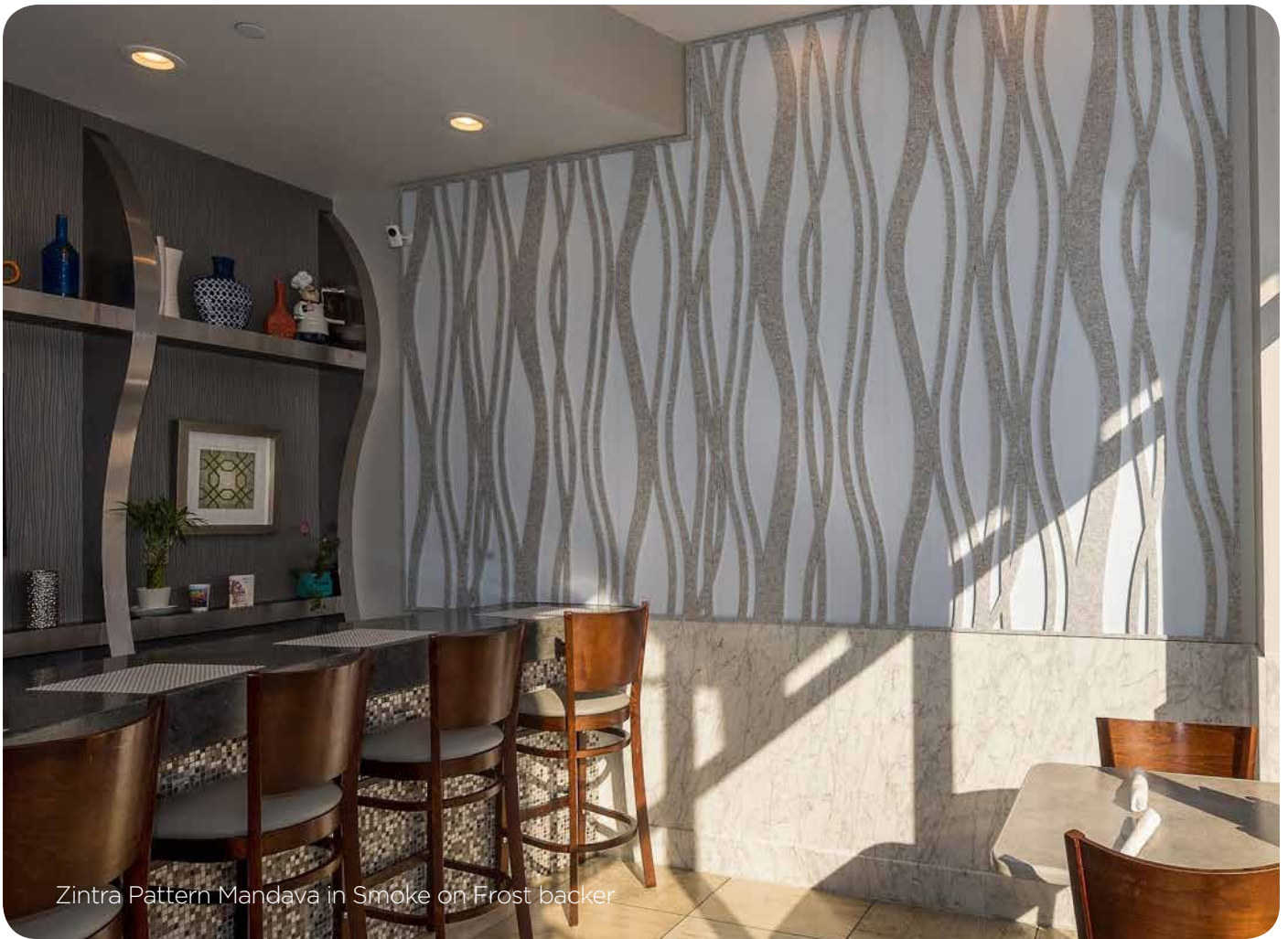

Zintra Pattern Mandava in Smoke on Frost backer



Zintra Pattern Fishbone in Greige on Sky backer



Zintra Pattern Setro in Slate on Chambray backer

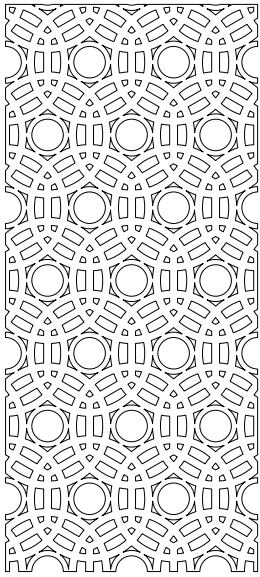

ABHAYA

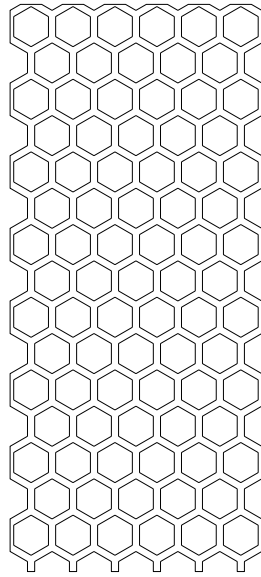

ASIATIC

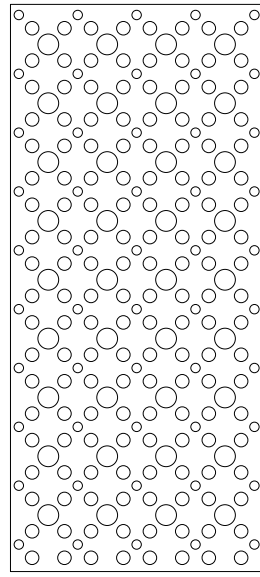

ASTRA

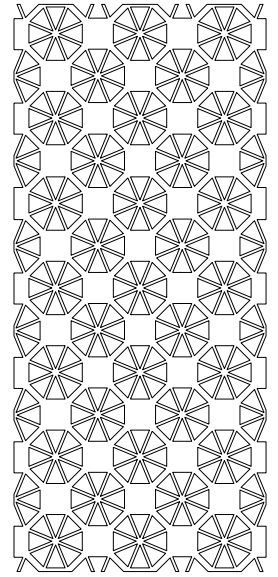

BENGAL

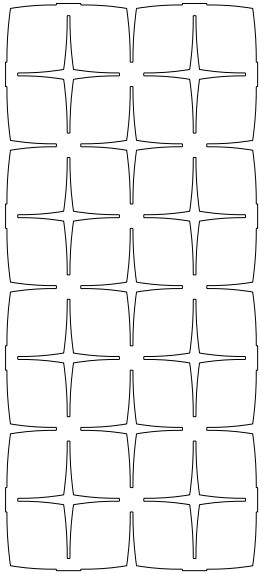

DEVRAJ

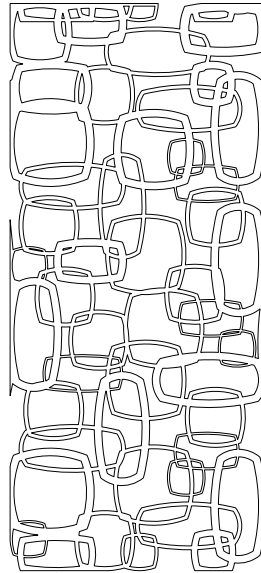

ELEPHANTA

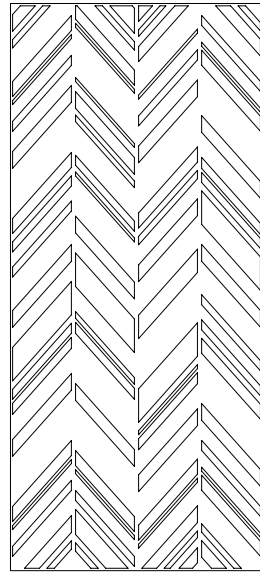

FISHBONE

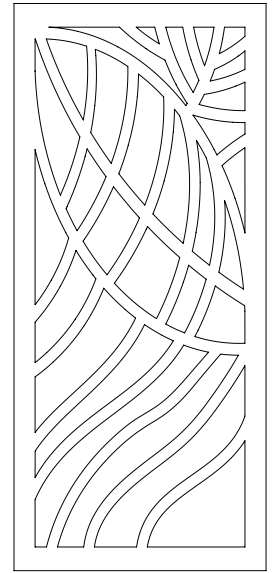

FOLIAGE

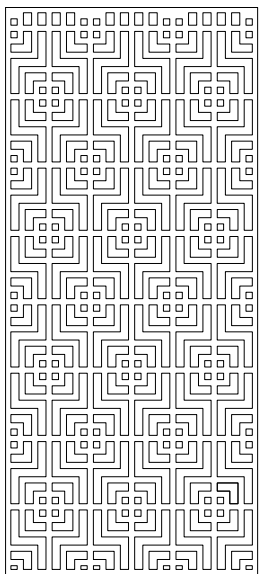

INDUS

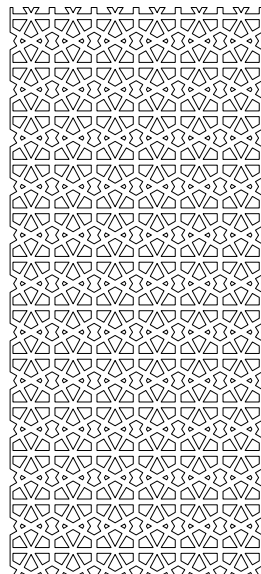

KALI



KERALA

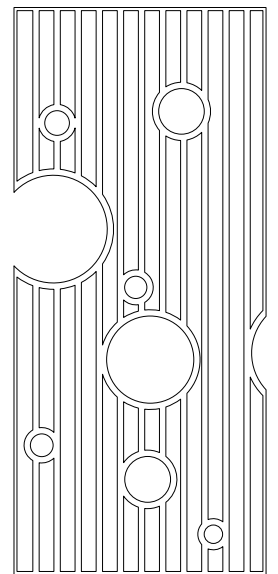

KRISHNAN

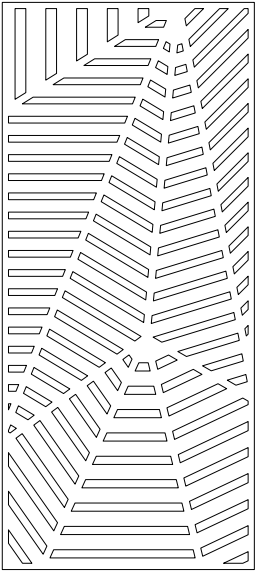

BHUSHAN

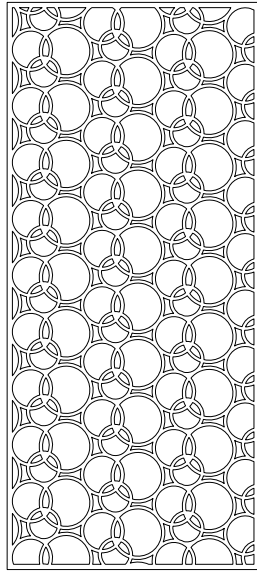

BHARATA

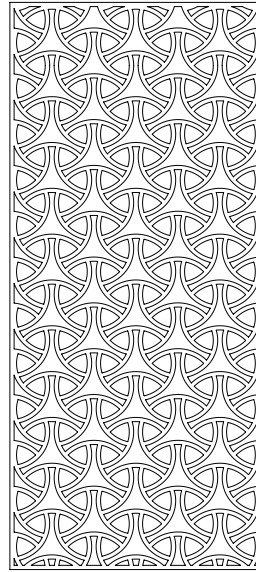

CIRQUE

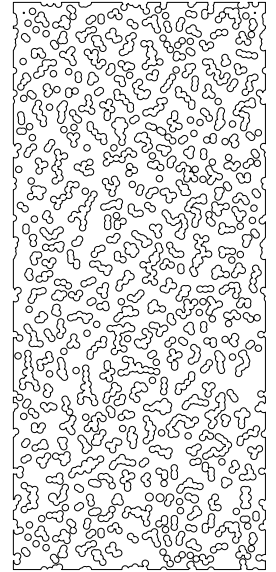

DEEPAK

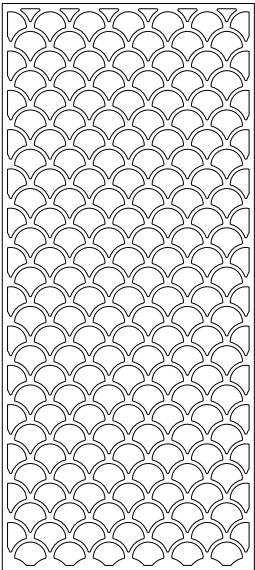

GADIVA



GINKGO

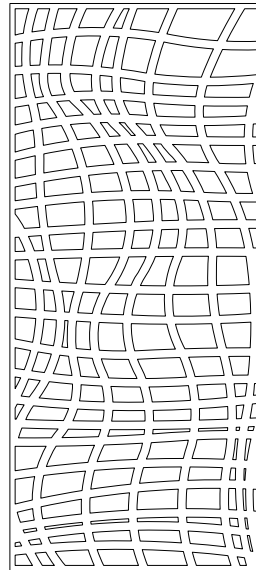

HAIMATI

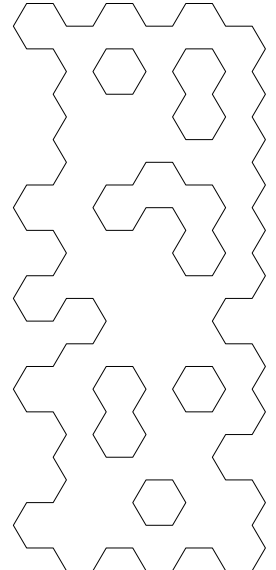

HEX

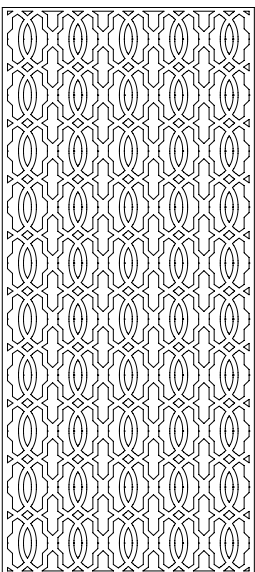

LINKS

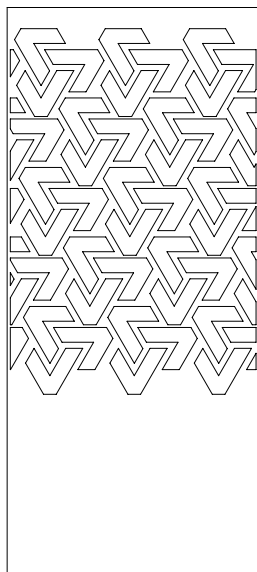

LOST

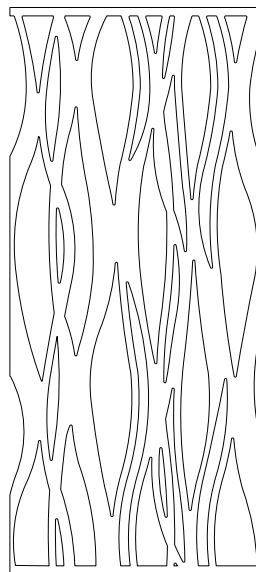

MANDAVA

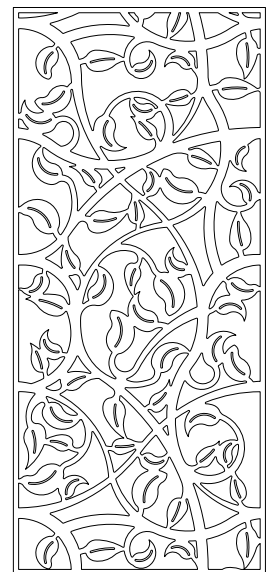

MALINI

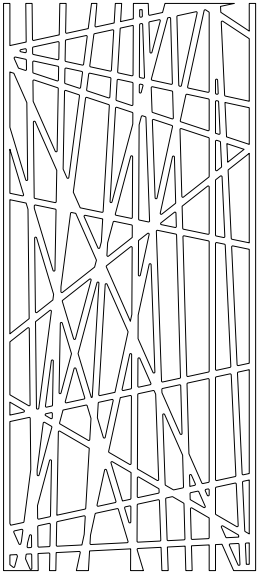

MONSOON

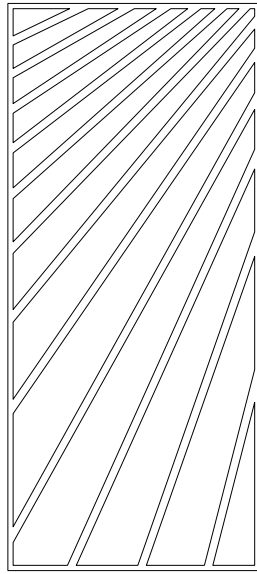

NADU

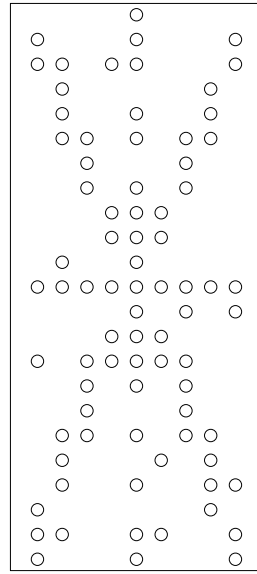

NOKTALAR

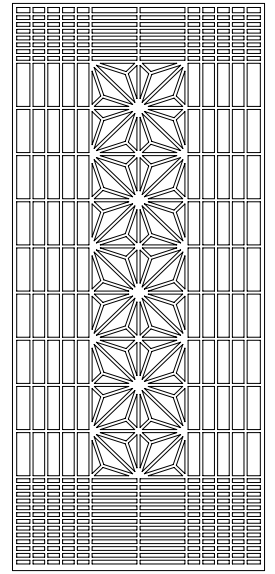

ORIGAMI

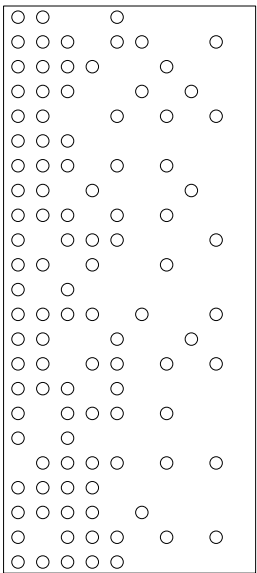

PUNTO

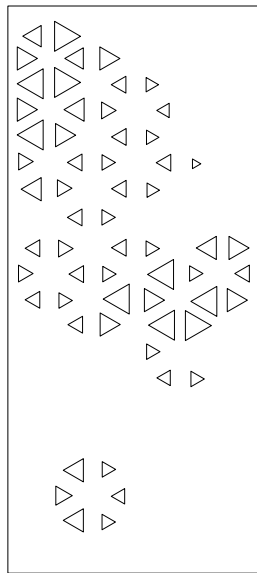

PROSE

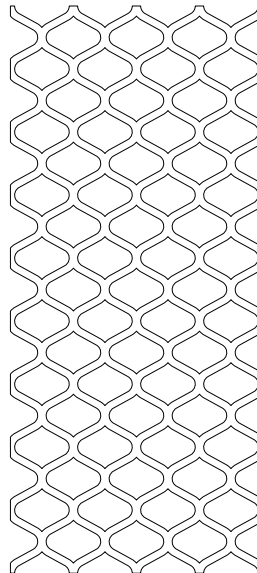

RAJA

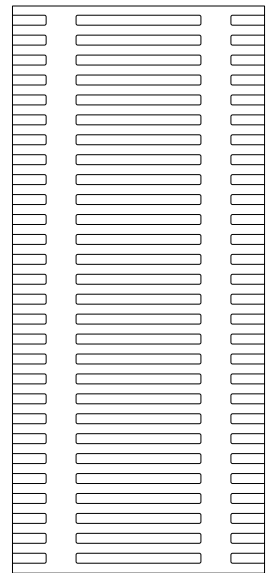

SAKRA

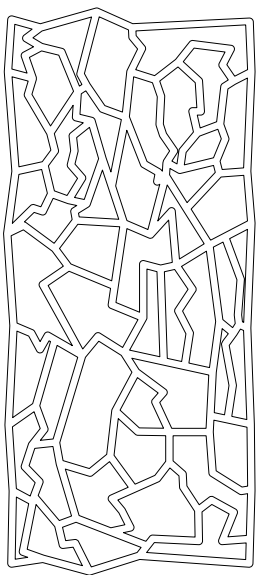

SIPTICAL

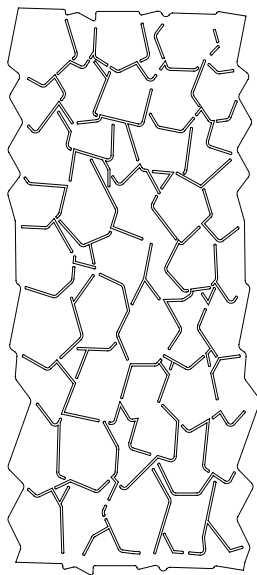

STONE AGE

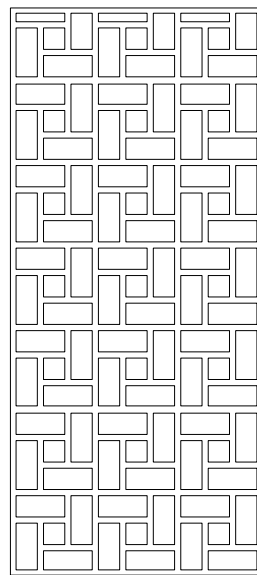

SUTRA

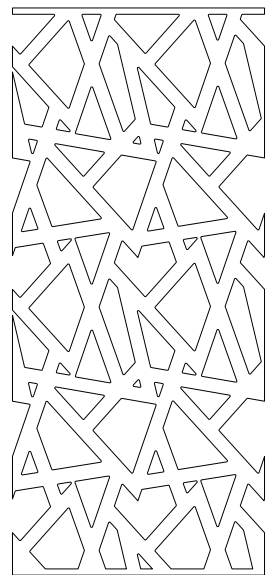

TELUGU

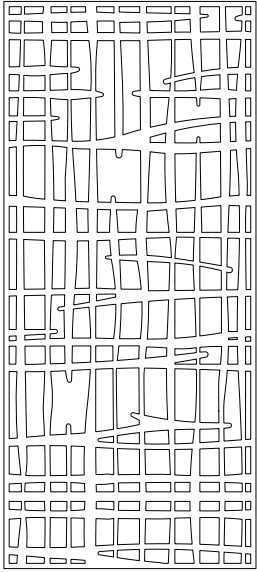

PADMESH

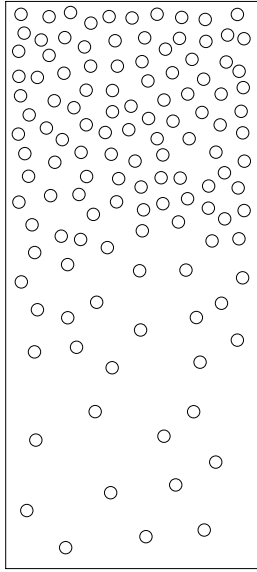

PERDITA

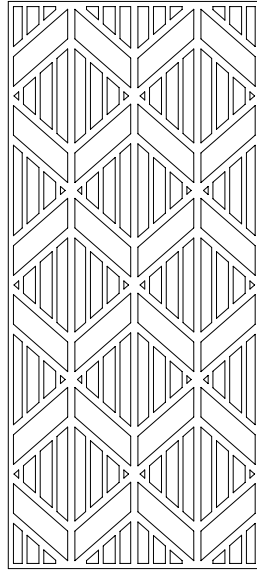

PIVOT

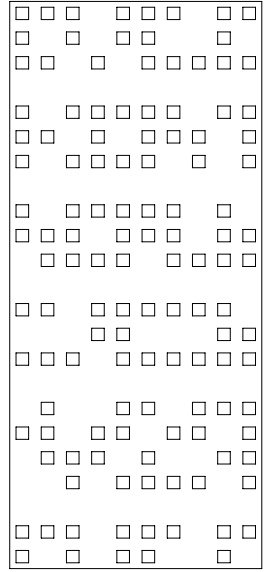

PIXEL

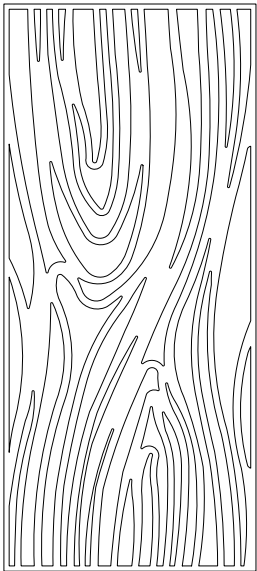

SANKARAN

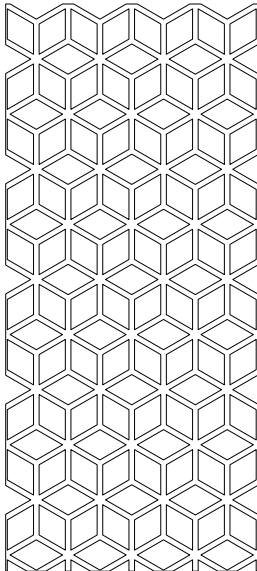

SANSKRIT

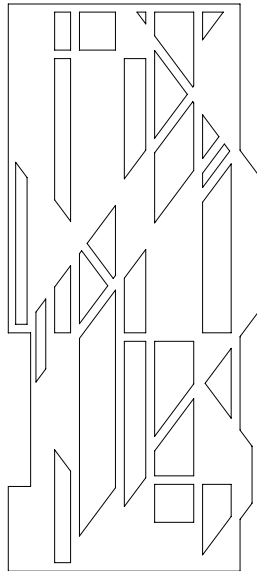

SETRO

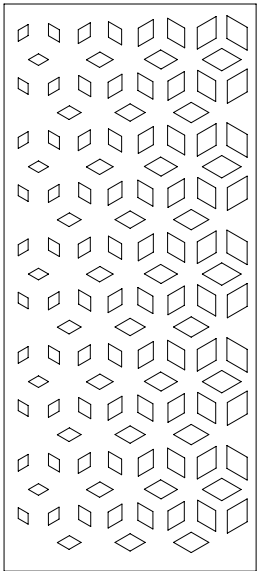

SHARD

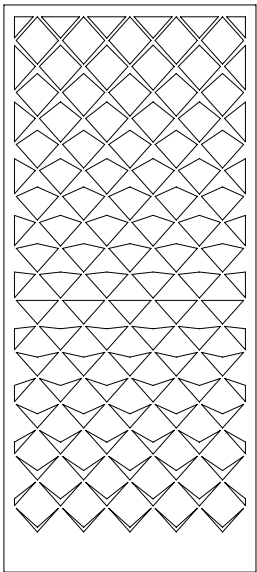

VANISHING

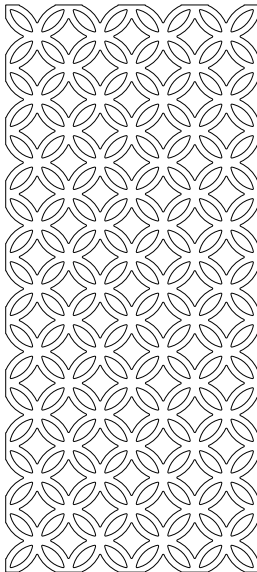

VEDIC

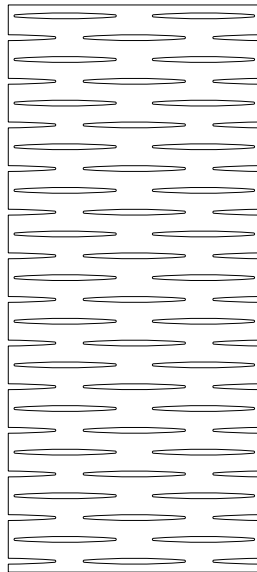

WAMIKA



Zintra Pattern Wamika in Malachite, shown with Zintra Sliding Screen hardware

ZINTRA SLIDING SCREENS



Zintra Pattern Devraj in Linen, shown with Zintra Sliding Screens hardware

ZINTRA SLIDING SCREENS COMBINES ZINTRA PATTERNS WITH EASY TO INSTALL HARDWARE, ALLOWING FLEXIBLE ROOM DIVISION WITH OUTSTANDING ACOUSTIC QUALITY.



Zintra Pattern Bhushan in Sky, shown with Zintra Sliding Screens hardware

SLIDING SCREENS SPECIFICATIONS

DIMENSIONS	2438mm x 68.6mm x 35.6mm [8' x 2.7" x 1.4"]
HARDWARE FINISH	Double Sliding Track - Powdercoated aluminium (Black or White) Roller Cover Plate - Powdercoat to match track
NOTES	Sliding Screen includes Rollers and Double Sliding Track. See pages 109, 110 for hardware detail. Only available in Zintra 12mm [1/2"] Sheets. Custom finishes available for an additional fee and extended lead time. For complete specification and installation information, visit baresque.com.au/brand/zintra



SLIDING TRACK ASSEMBLY

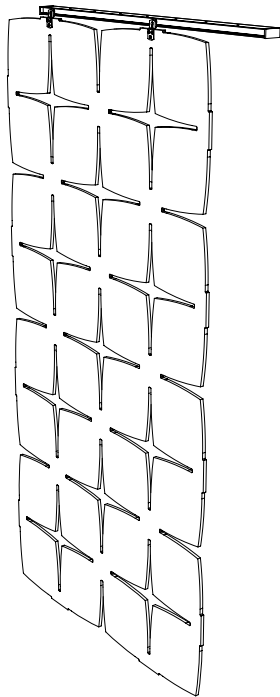
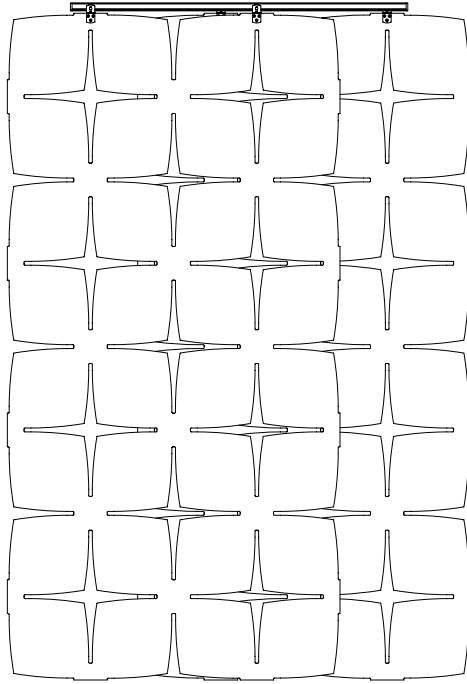

ONE SCREEN

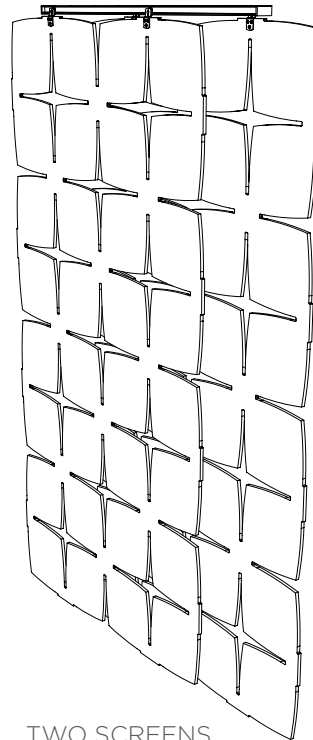

TWO SCREENS



Zintra Pattern Shard in Cobalt, shown with Floor to Ceiling including Cable Side-Gripper Single

ZINTRA FLOOR TO CEILING



Zintra Pattern Punto in Pebble, shown with Floor to Ceiling cables and Cable Standoffs

UTILIZING A STEEL CABLE TO SUSPEND ZINTRA SHEETS OR PATTERNS, FLOOR TO CEILING IS AN EASY-TO-INSTALL AND COST-EFFECTIVE ROOM DIVIDING SOLUTION.

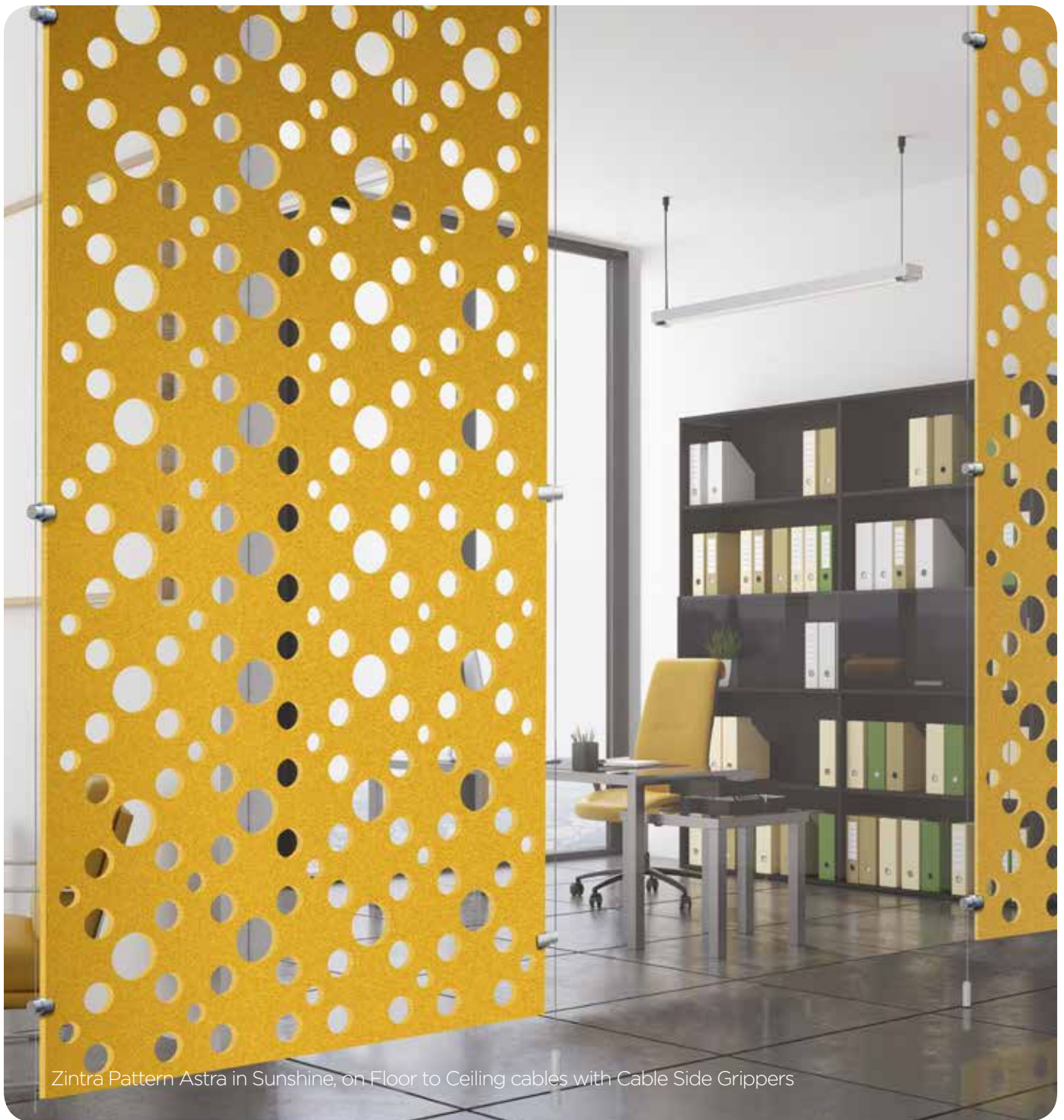

Zintra Pattern Astra in Sunshine, on Floor to Ceiling cables with Cable Side Grippers

FLOOR TO CEILING SPECIFICATIONS

DIMENSIONS	Floor to Ceiling Cable 4000mm [157"] long	
HARDWARE	Floor to Ceiling Cable Kit	Clear anodized aluminium fittings with zinc plate steel cable
FINISH	Cable Side Gripper - Single or Double	Clear anodized aluminium
	Cable Standoff	Clear anodized aluminium body with stainless steel (satin polish) head
NOTES	Floor To Ceiling includes Adjustable Cable Kit and choice of Cable Side Grippers or Standoff to suit. See page 108 for hardware detail. For complete specification and installation information, visit baresque.com.au/brand/zintra	



CABLE SIDE GRIPPER

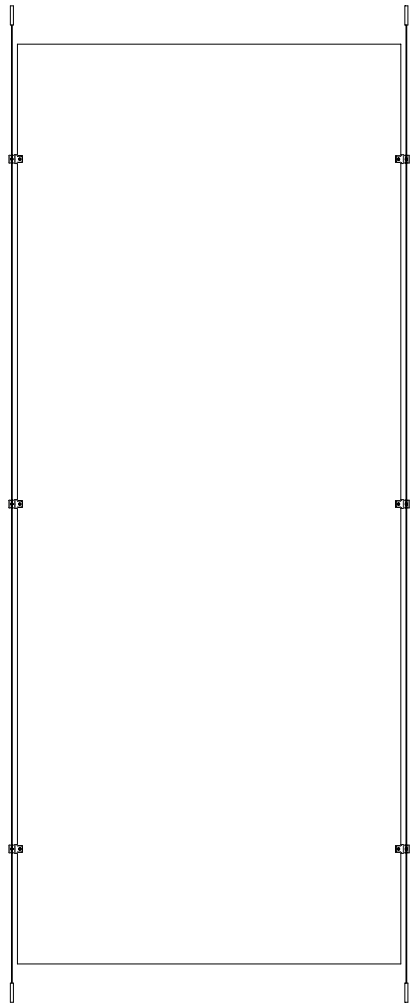

CABLE STANDOFF

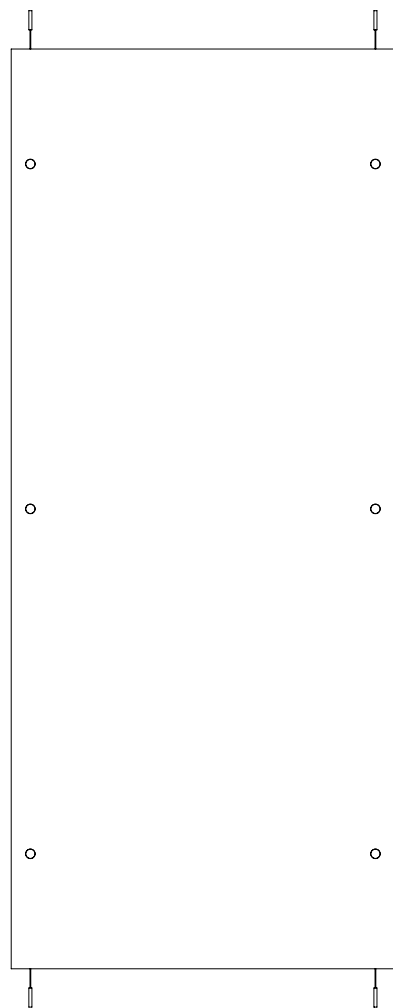

* shown with Cable Standoff Extended Head

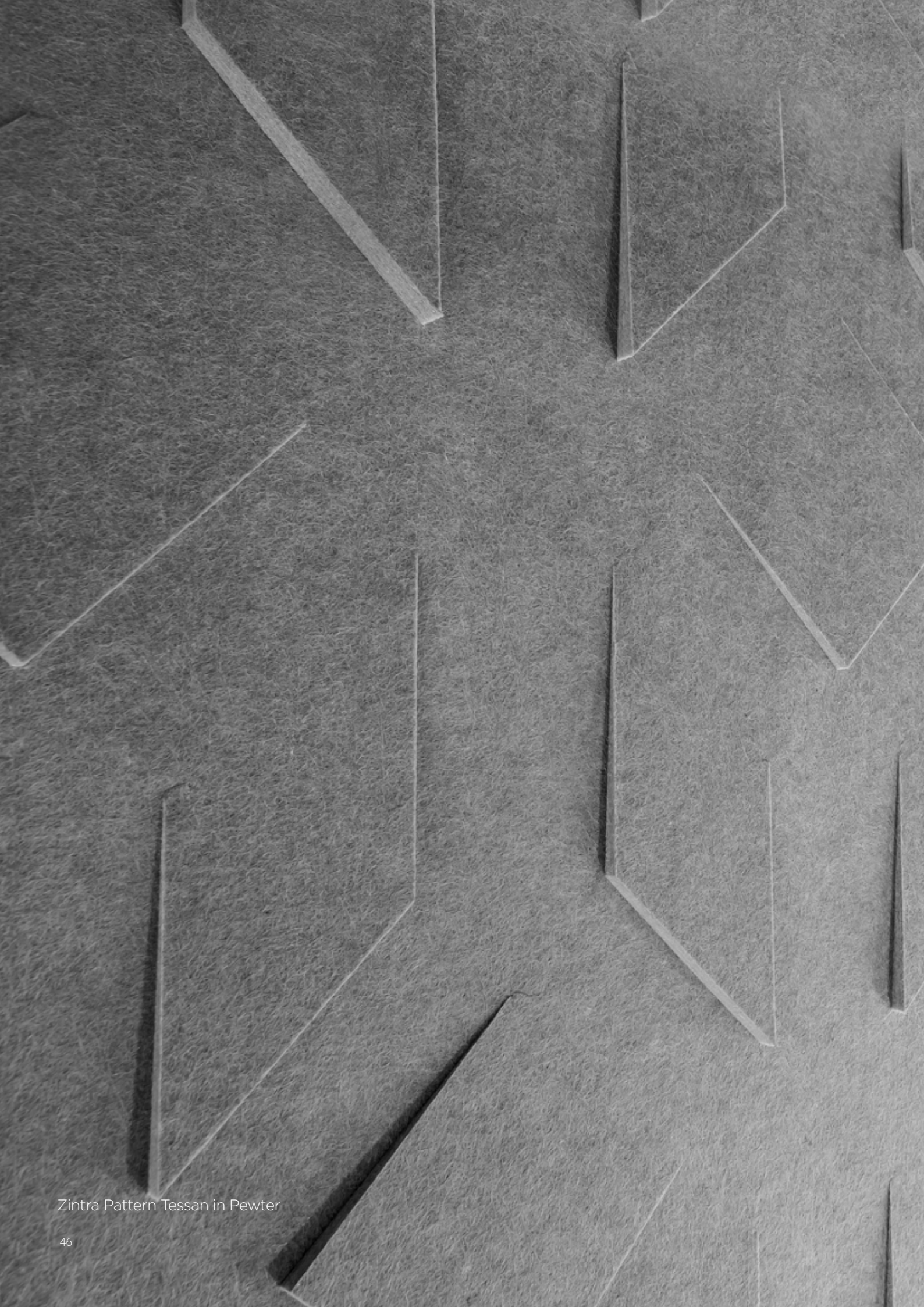

Zintra Pattern Tessan in Pewter

ZINTRA TEXTURES



Zintra Texture Cercles in Sky

ZINTRA ACOUSTIC TEXTURES THREE-DIMENSIONAL RELIEFS CREATE DIMENSION AND ACOUSTIC REFRACTION ON WALLS. EACH CAREFULLY CUT SHAPE PROJECTS FROM THE SURFACE OF THE PANEL. IDEAL FOR NOISY SPACES WHERE GOOD ACOUSTIC QUALITY AND AESTHETICS ARE REQUIRED.



Zintra Texture Echelle in Pewter

TEXTURES SPECIFICATIONS

DIMENSIONS	2745mm x 1220mm x 24mm [108" x 48" x 1"]
COLOURS	Available in all twenty Zintra 12mm [1/2"] Sheet colours. See page 11.
NRC RATING	0.45. See pages 8-9.
NOTES	Custom sizes available. Only available in Zintra 12mm [1/2"] Sheets. For complete specification and installation information, visit baresque.com.au/brand/zintra



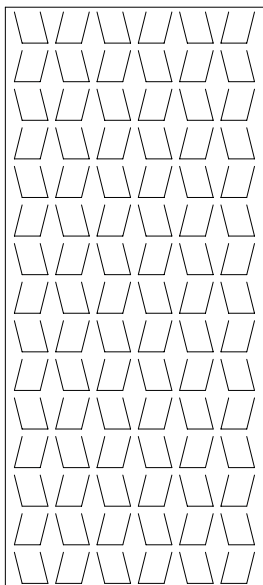

CARRE

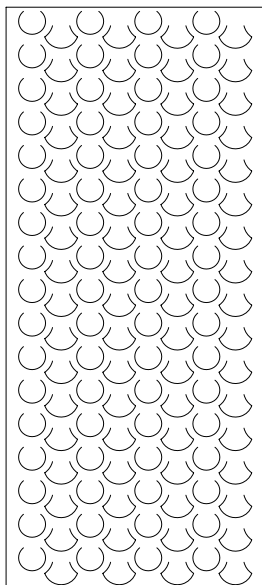

CERCLES

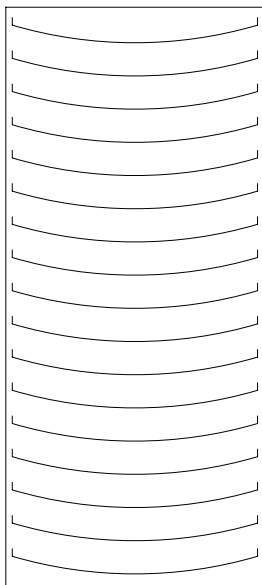

CORBE

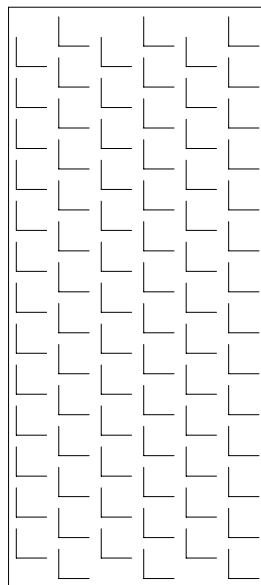

DIAMONT

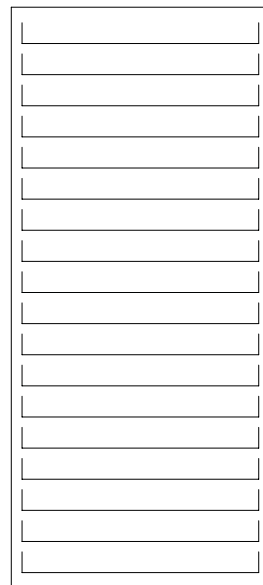

DROIT

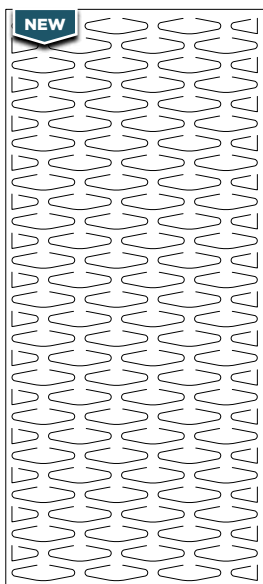

ECHELLE

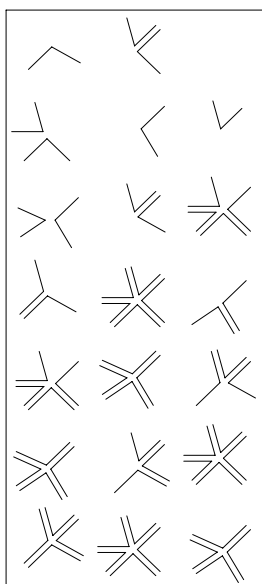

ETOILE

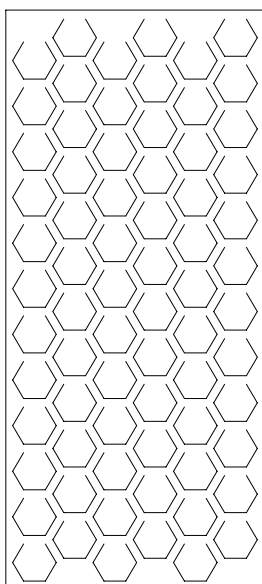

HEXAGONE

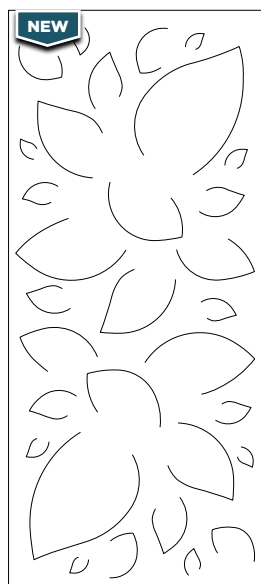

NENUPHAR

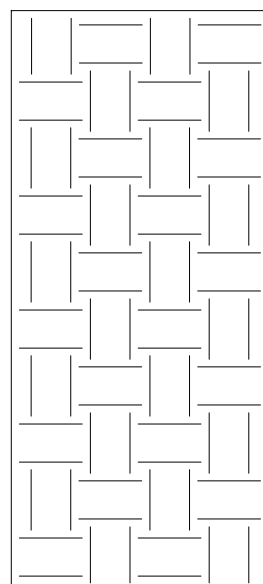

TISSAGE

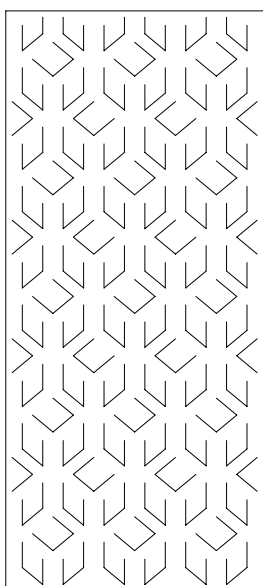

TESSAN

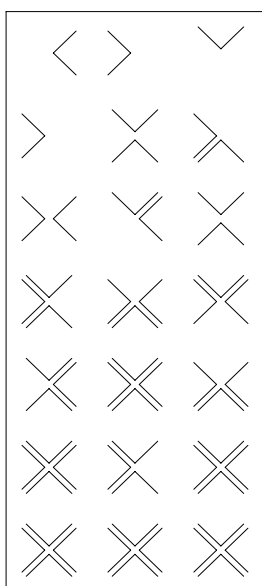

SIGNE

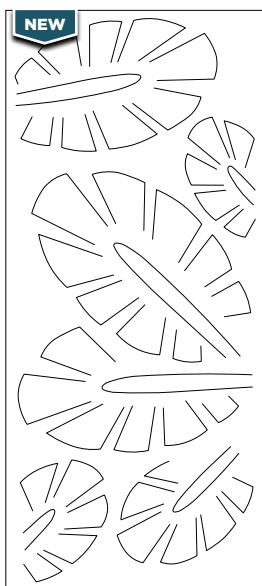

PAUME

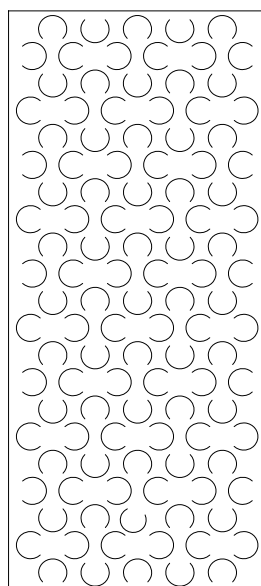

TRAPPE

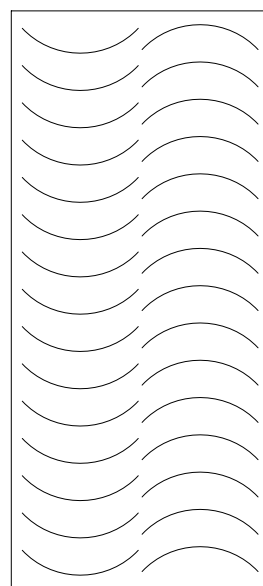

VAGUE

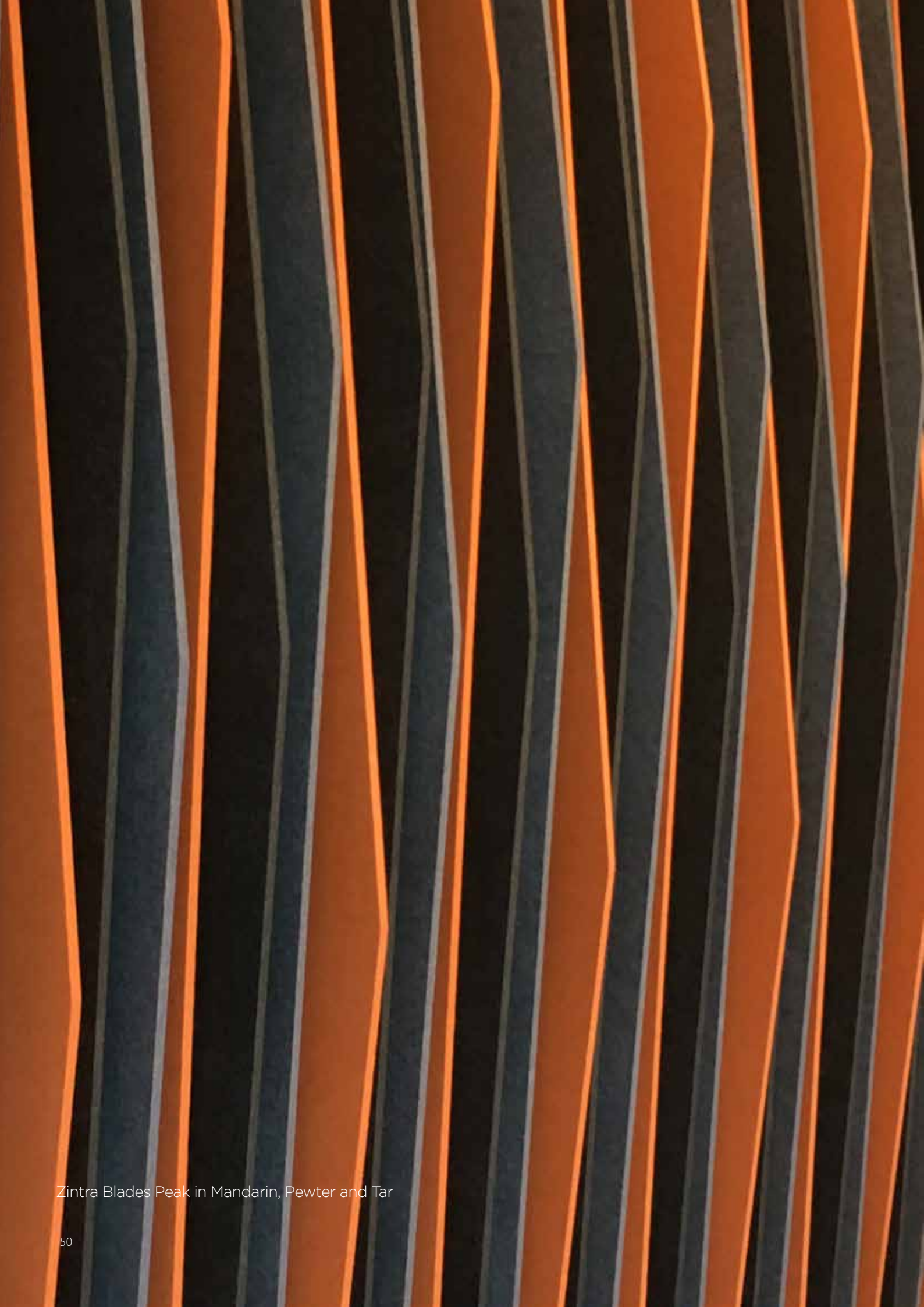

Zintra Blades Peak in Mandarin, Pewter and Tar

ZINTRA BLADES



Zintra Blades Swell in Smoke

THESE WALL MOUNTED SYSTEMS SHOWCASE ZINTRA'S FLEXIBLE CHARACTERISTICS. COMBINING A DYNAMIC AESTHETIC APPEAL AND ACOUSTIC PERFORMANCE, BLADES ARE AN EASY-TO-INSTALL SOLUTION. THE INCREASED SURFACE AREA OF THE VERTICAL BLADES RESULTS IN GREATER ABSORPTION OF SOUND COMPARED TO FLAT PANELS.



Zintra Blades Peak in Ochre

BLADES SPECIFICATIONS

DIMENSIONS	SMALL	1375mm x 1220mm x 114mm [54" x 48" x 4.5"]
	LARGE	2745mm x 1220mm x 114mm [108" x 48" x 4.5"]
COLOURS	Available in all twenty Zintra 12mm [1/2"] Sheet colours. See page 11.	
HARDWARE FINISH	Square Tube 25mm x 25mm [1" x 1"] - Powdercoat Black or White	
NRC RATING	0.95. See pages 8-9.	
NOTES	Only available in Zintra 12mm [1/2"] Sheets.	
	Blades includes Square Tube. See page 111 for hardware detail.	
	Multi-colour available for an additional fee.	
	For complete specification and installation information, visit baresque.com.au/brand/zintra	



STANDARD BLADE CONFIGURATIONS

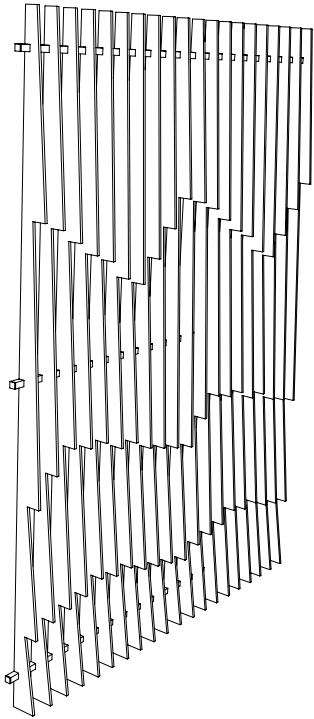

BOLT

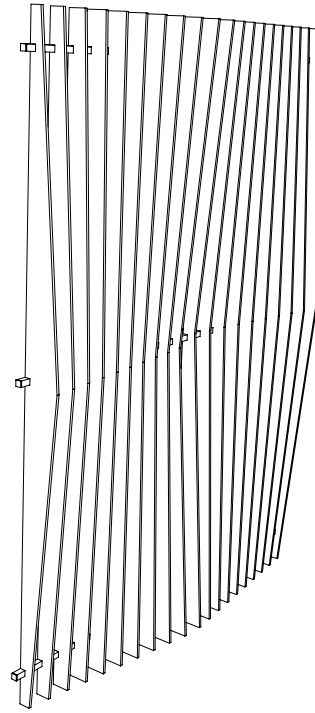

RIDGE

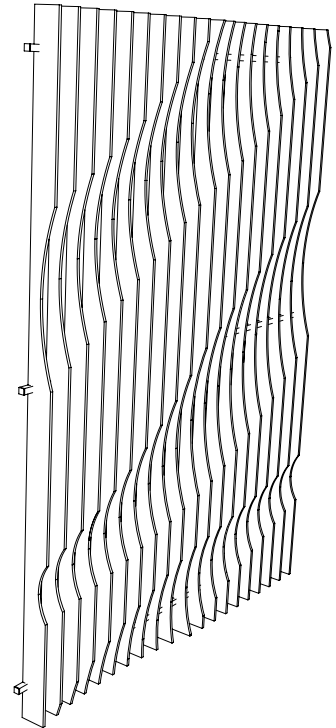

CANYON

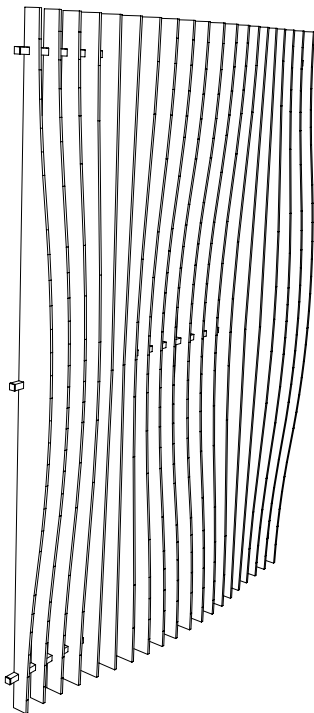

SWELL

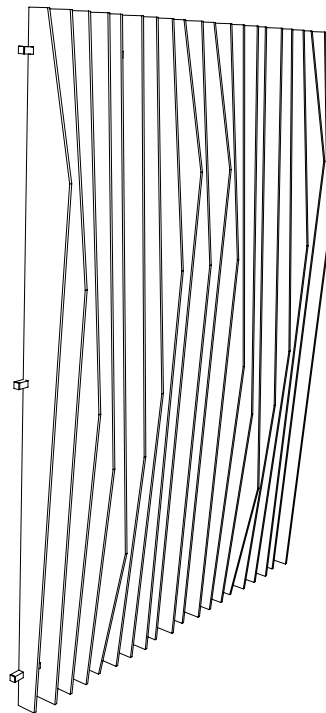

PEAK

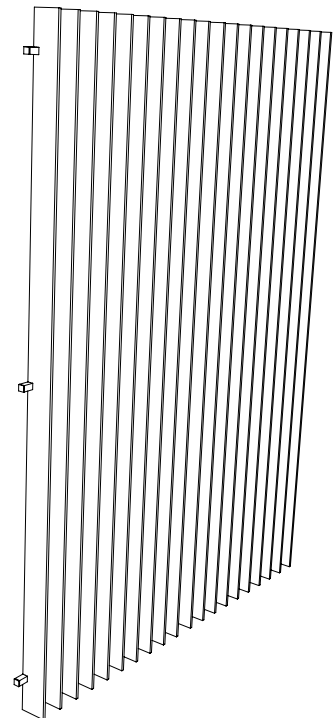

SQUARE

* Two Large Blade Systems shown

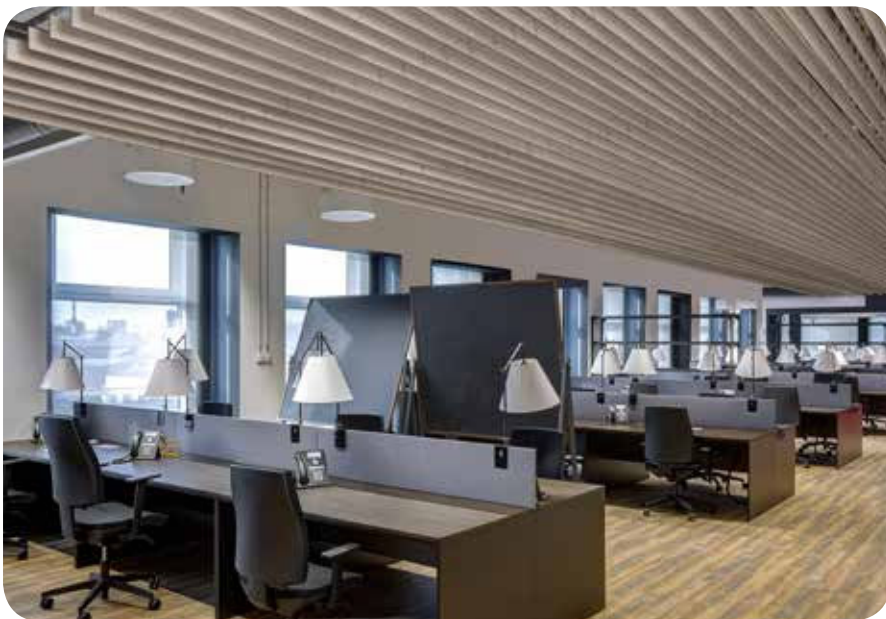

CEILINGINGS



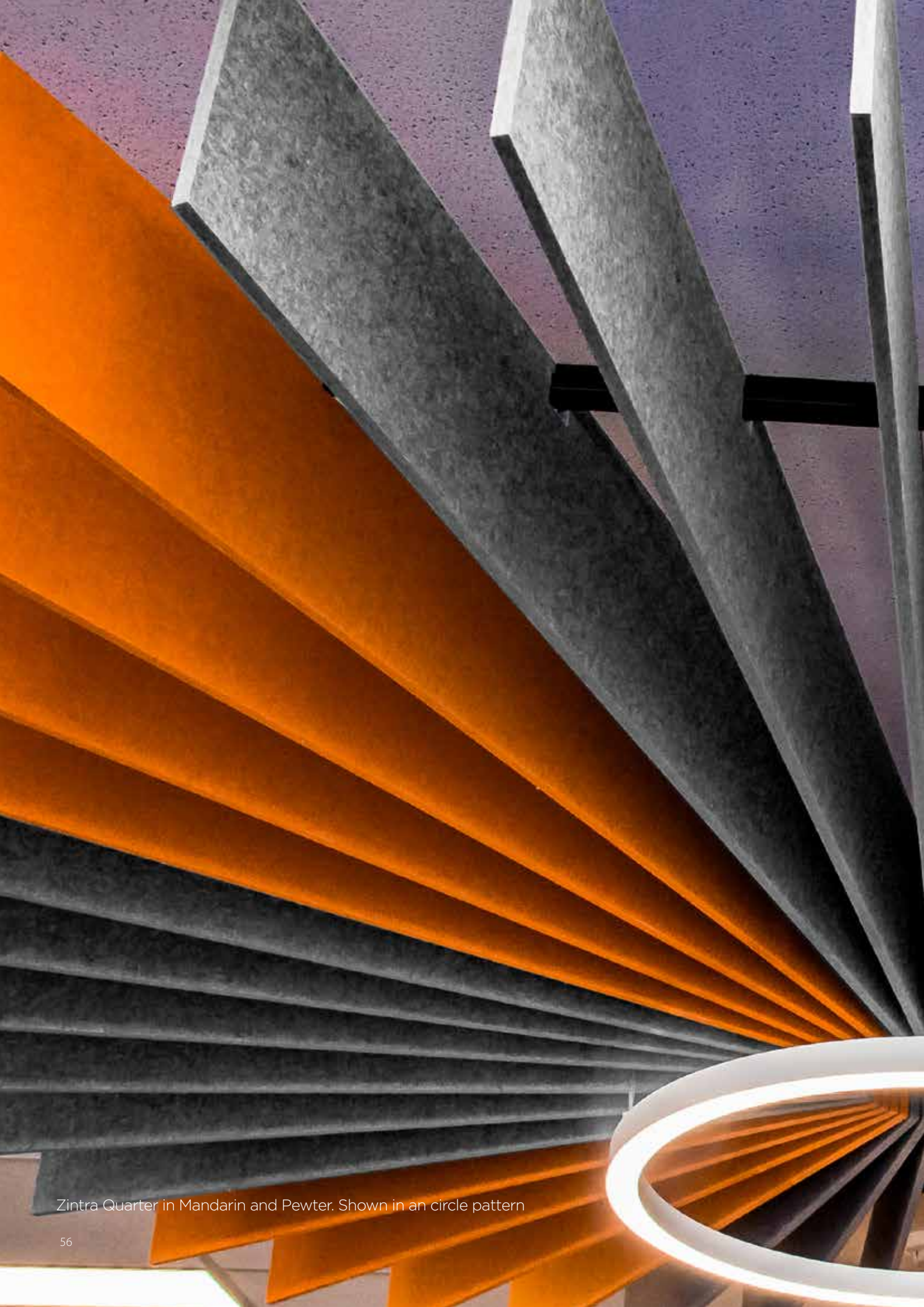

Zintra Quarter in Mandarin and Pewter. Shown in an circle pattern

ZINTRA QUARTER



Zintra Quarter in Linen. Shown in a circle pattern

SIMILAR TO ZINTRA'S BAFFLE SYSTEMS, ZINTRA QUARTER TAKES THE BAFFLE A STEP FURTHER. ARRAYED BAFFLES CREATE A QUARTER OF A CIRCLE. USE FOUR OF THEM TO MAKE A FULL CIRCLE OR ALTERNATE DIRECTIONS FOR AN EYE-CATCHING ZIG ZAG PATTERN.

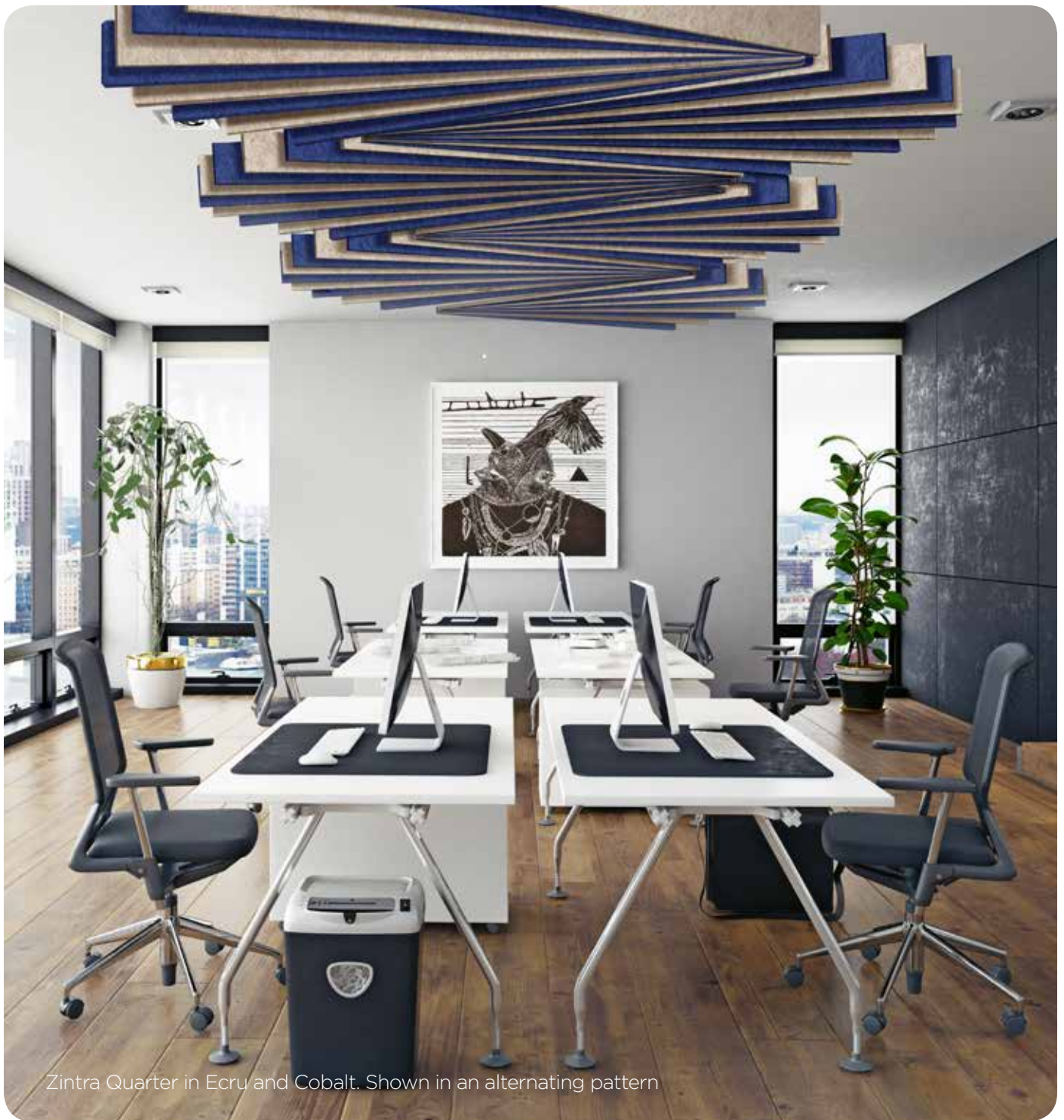

Zintra Quarter in Ecrú and Cobalt. Shown in an alternating pattern

QUARTERS SPECIFICATIONS

- DIMENSIONS** 1828mm x 1400mm x 120mm [72" x 55" x 4.7"]
 1828mm x 1400mm x 240mm [72" x 55" x 9.5"]
- COLOURS** Available in all twenty Zintra 12mm [1/2"] colours. See page 11.
- HARDWARE FINISH** Square Tube 25mm x 25mm [1" x 1"] - Powdercoat Black or White
- NRC RATING** 0.95. See pages 8-9.
- NOTES** Only available in Zintra 12mm [1/2"] Sheets.
 Quarter Baffle includes Adjustable Cable Kit and Square Tube.
 See pages 108 and 111 for hardware detail.
 Longer Cables, multi-colour and Digital Print available for an additional fee.
 For complete specification and installation information, visit baresque.com.au/brand/zintra



QUARTER BAFFLE

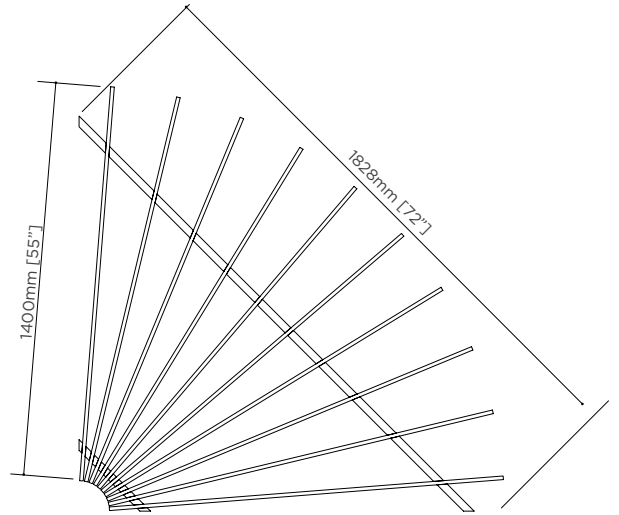
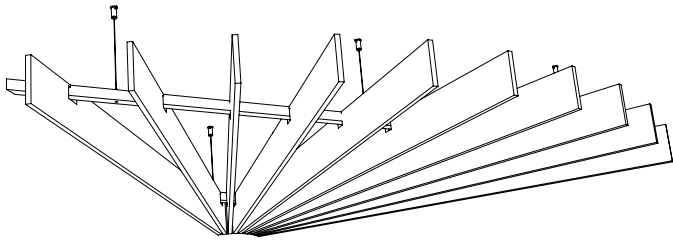

CIRCLE

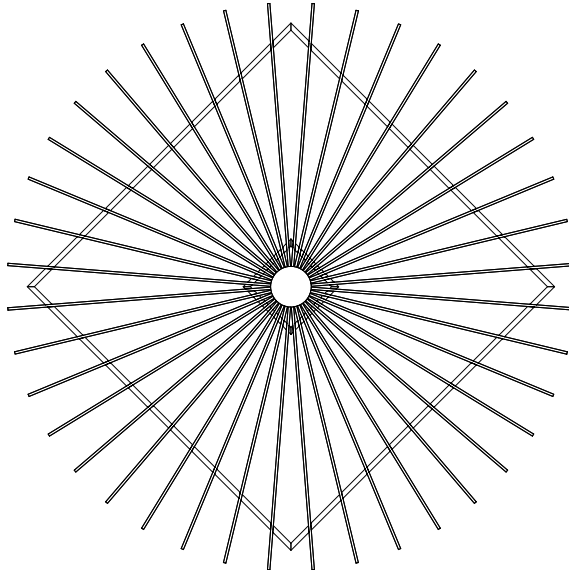

ALTERNATING

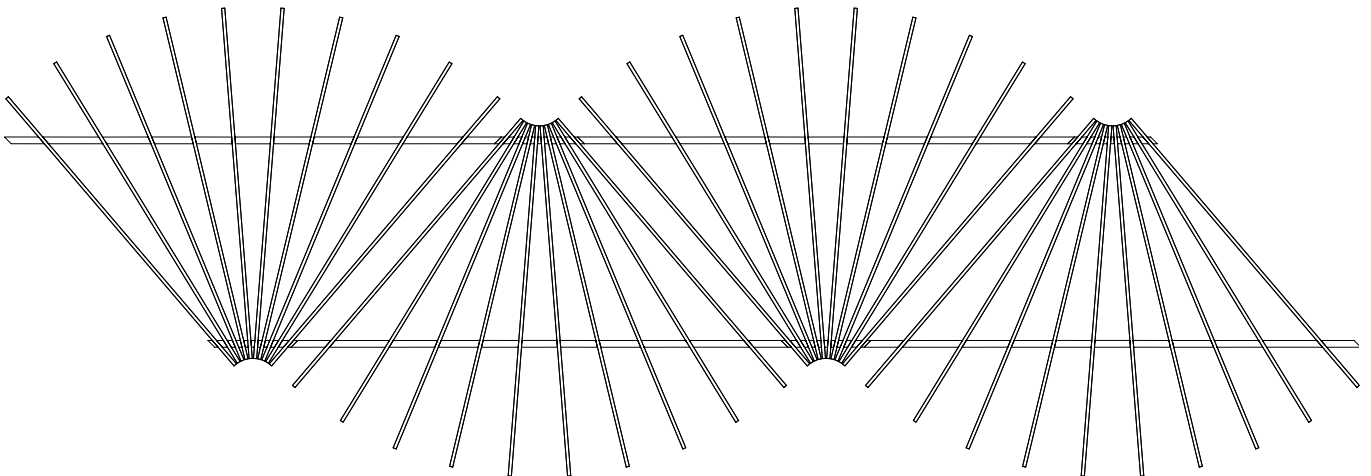



Zintra Box Baffles Random in Cadet, Malachite and Fossil

ZINTRA BOX BAFFLES



Zintra Box Baffles Uniformed Small in custom digital print graphic

SUSPENDED BOX-SHAPED BAFFLES HUNG IN PERFECTLY SPACED ROWS CREATE THESE HIGH PERFORMING BAFFLES. THE BOX SHAPE FEATURE NOT ONLY LOOKS MORE SUBSTANTIAL, IT ALSO INCREASES THE NRC RATING BY CAPTURING SOUND WITHIN. SELECT THE SAME SHAPED BAFFLES OR MIX THEM UP FOR ADDED DIMENSION.

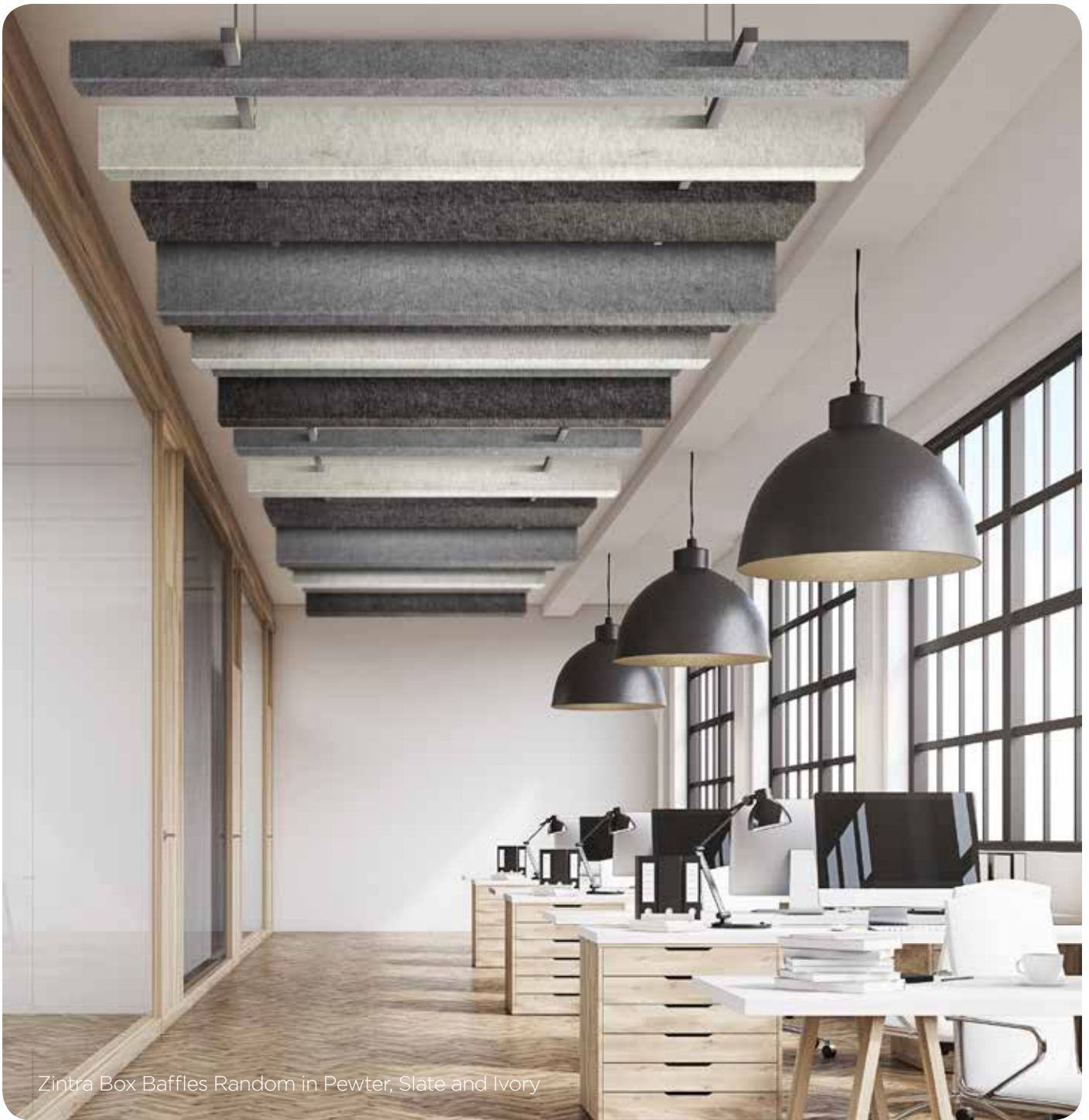

Zintra Box Baffles Random in Pewter, Slate and Ivory

BOX BAFFLES SPECIFICATIONS

DIMENSIONS	RANDOM	2400mm x 1000mm x 200mm [94.5" x 39.4" x 8"]
	MIXED	2400mm x 1000mm x 200mm [94.5" x 39.4" x 8"]
	UNIFORMED LOW	2400mm x 1000mm x 100mm [94.5" x 39.4" x 4"]
	UNIFORMED HIGH	2400mm x 1000mm x 200mm [94.5" x 39.4" x 8"]

COLOURS Available in all twenty Zintra 12mm [1/2"] Sheet colours. See page 11.

HARDWARE FINISH Square Tube 25mm x 25mm [1" x 1"] - Powdercoat Black or White.

NRC RATING 0.95. See pages 8-9.

NOTES Only available in Zintra 12mm Sheets.

Box Baffle includes Adjustable Cable Kit and Square Tube.

See pages 108 and 111 for hardware detail.

Longer cables, multi-colour and Digital Print available for an additional fee.

For complete specification and installation information, visit baresque.com.au/brand/zintra



RANDOM

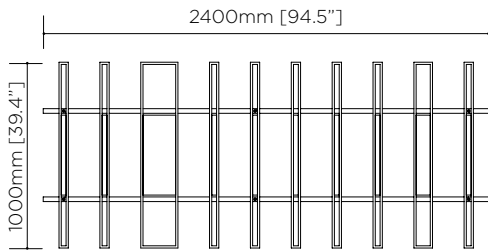
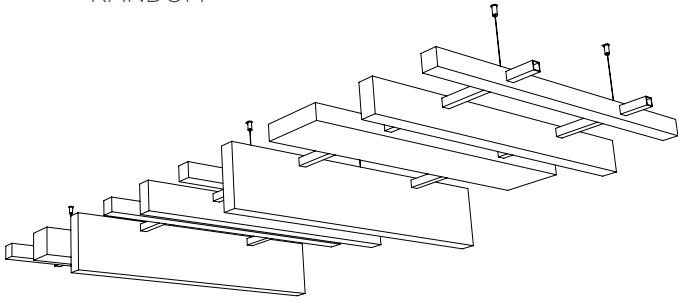

MIXED

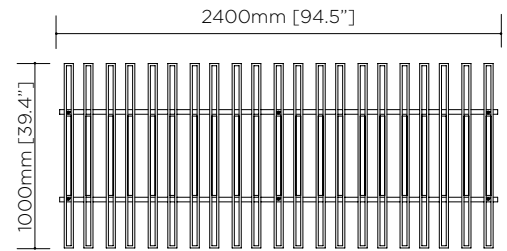
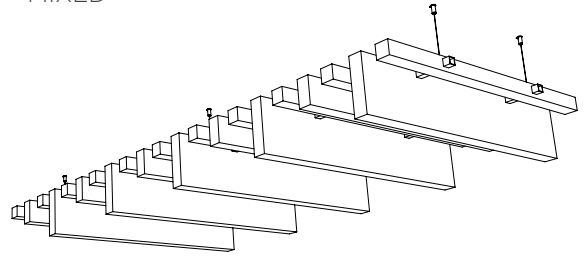

UNIFORMED LOW

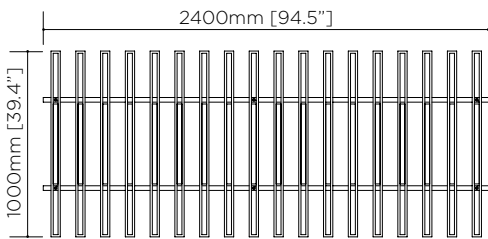
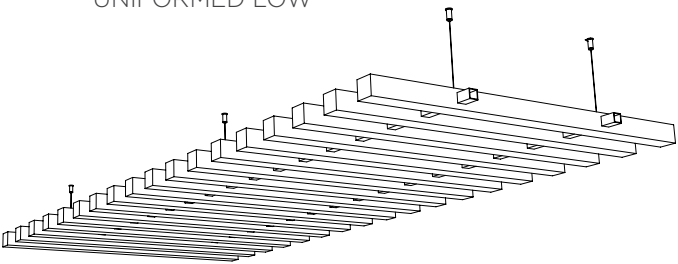

UNIFORMED HIGH

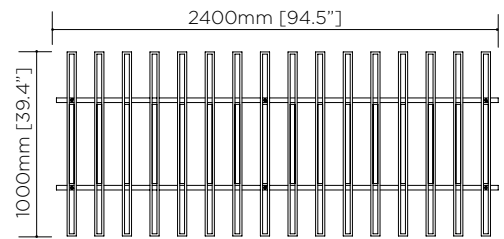
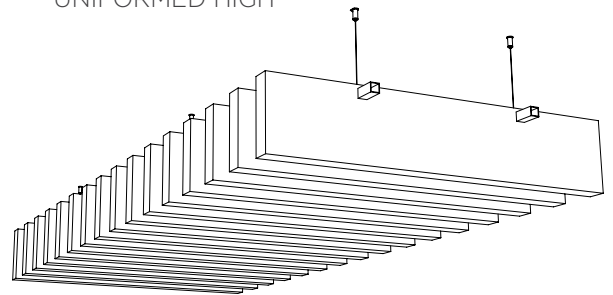

BOX BAFFLE A

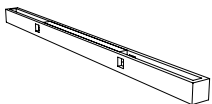

1000mm x 50mm x 50mm
[39.4" x 2" x 2"]

BOX BAFFLE B

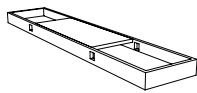

1000mm x 200mm x 50mm
[39.4" x 8" x 2"]

BOX BAFFLE C

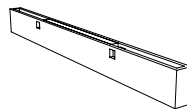

1000mm x 100mm x 50mm
[39.4" x 4" x 2"]

BOX BAFFLE D

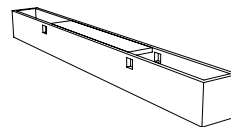

1000mm x 100mm x 100mm
[39.4" x 4" x 4"]

BOX BAFFLE E

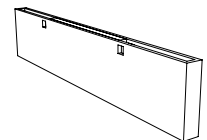

1000mm x 200mm x 50mm
[39.4" x 8" x 2"]



Zintra Baffle Systems Ridge in Cadet

ZINTRA BAFFLE SYSTEMS



Zintra Ridges Baffle Systems in Cobalt

Corruption and Crime Commission WA Office
Designed by: Sph Architecture & Interiors
Photographed by: D-Max Photography

ZINTRA BAFFLE SYSTEMS ARE AN INNOVATIVE REPLACEMENT TO A MINERAL FIBER CEILING SYSTEM. EASY TO ASSEMBLE AND INSTALL, THEY ARE AVAILABLE IN A LARGE ARRAY OF DESIGNS. BAFFLE SYSTEMS ARE IDEALLY SUITED TO LARGE NOISY SPACES IN EDUCATIONAL INSTITUTIONS, SHOPPING CENTERS, OFFICES, RESTAURANTS AND AIRPORTS.



Zintra Bolt Baffle System in Echru

BAFFLE SYSTEMS SPECIFICATIONS

DIMENSIONS	SMALL BAFFLE 1220mm x 1220mm [48" x 48"] LARGE BAFFLE 2745mm x 1220mm [108" x 48"]
DEPTHS	120mm [4.8"] or 240mm [9.5"]
COLOURS	Available in all twenty Zintra 12mm [1/2"] Sheet colours. See page 11.
HARDWARE FINISH	Square Tube 25mm x 25mm [1" x 1"] - Powdercoat Black or White
NRC RATING	0.95. See pages 8-9.
NOTES	Only available in Zintra 12mm [1/2"] Sheets. Baffle Systems include Adjustable Cable Kit and Square Tube. See pages 108 and 111 for hardware detail. Longer cables, multi-colour and Digital Print available for an additional fee. For complete specification and installation information, visit baresque.com.au/brand/zintra



STANDARD BAFFLE SYSTEM OPTIONS:

LARGE BAFFLE

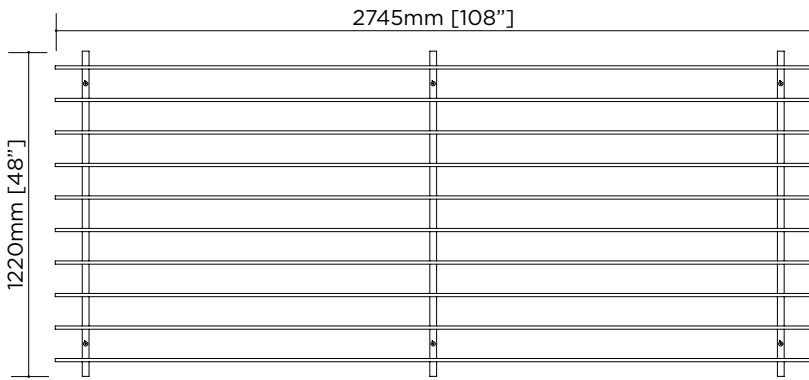

STANDARD

SMALL BAFFLE

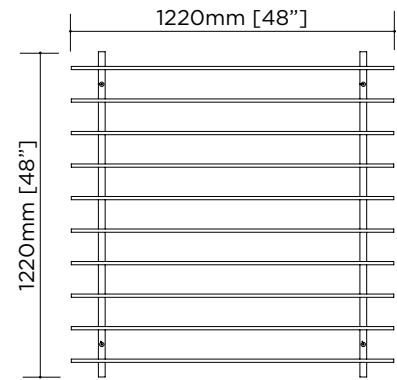

SQUARE

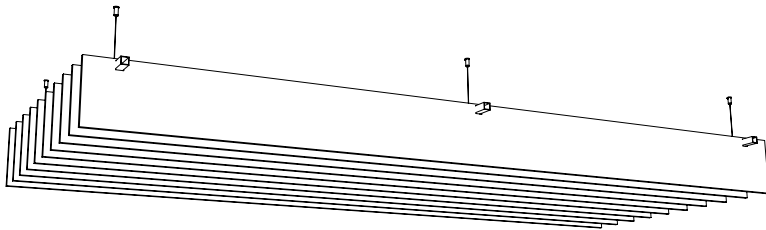

CANYONS

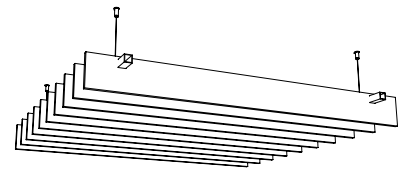

GORGE*

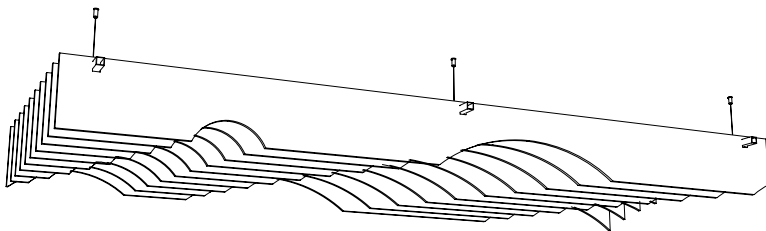

RIDGES

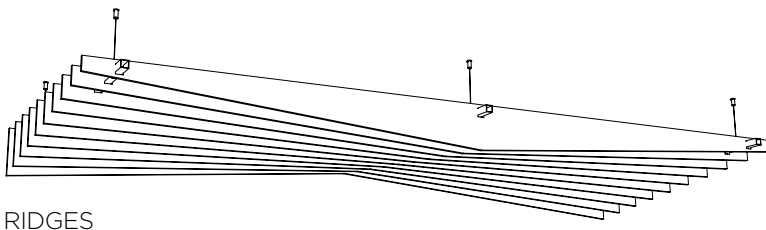

SWELL

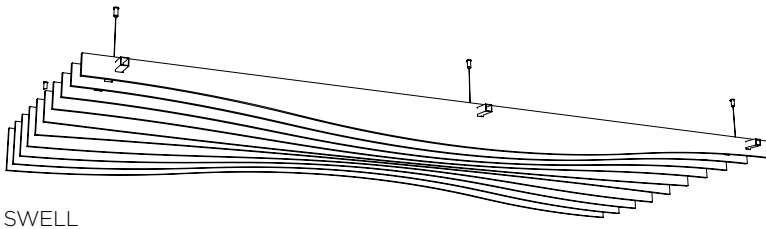

BOLT

*See specification sheet for exact details



Zintra Individual Baffles in Pewter with Silver Grommets

ZINTRA INDIVIDUAL BAFFLES



Zintra Individual Baffles in Linen and Fossil with Silver Grommets

EACH BAFFLE HANGS FROM IT'S OWN SET OF CABLES, PROVIDING FLEXIBILITY IN THE INSTALLATION AND DESIGN PROCESS. INDIVIDUAL BAFFLES WILL CONTROL ACOUSTICS IN ANY SCALED SPACE WHILE ACHIEVING AN ENDLESS ARRAY OF DYNAMIC LAYOUTS.

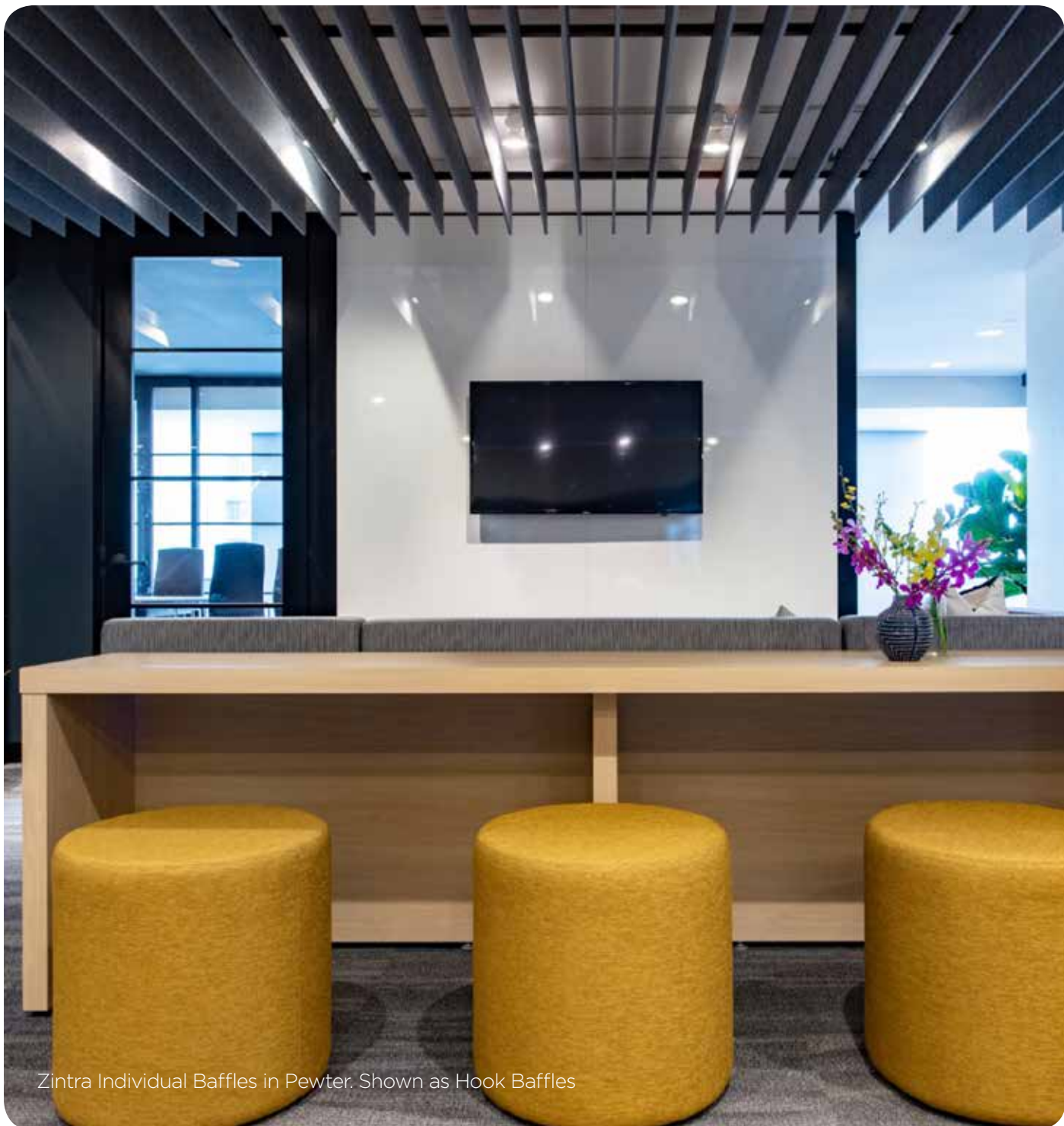

Zintra Individual Baffles in Pewter. Shown as Hook Baffles

INDIVIDUAL BAFFLES SPECIFICATIONS

LENGTH	Maximum 2745mm [108"]	
DEPTHS	120mm [4.8"] or 240mm [9.5"]	
COLOURS	Available in all twenty Zintra 12mm [1/2"] Sheet colours. See page 11.	
HARDWARE FINISH	Grommets - Silver or Brass	Twist Clip - Swivel - Clear Twist Clip - Loop - White S-Hook - Silver
NRC RATING	0.95. See pages 8-9.	
NOTES	<p>Only available in Zintra 12mm [1/2"] Sheets. Grommet - Adjustable Cable Kits included. Hook Baffle - S-Hook with either Twist Clip Swivel or Twist Clip Loop included See pages 108 - 111 for hardware detail. For complete specification and installation information, visit baresque.com.au/brand/zintra</p>	



GROMMET

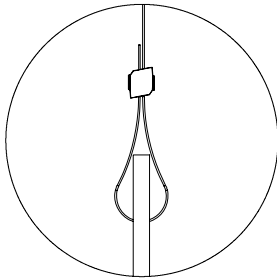
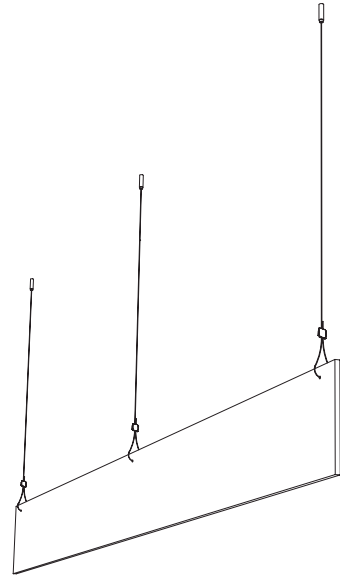
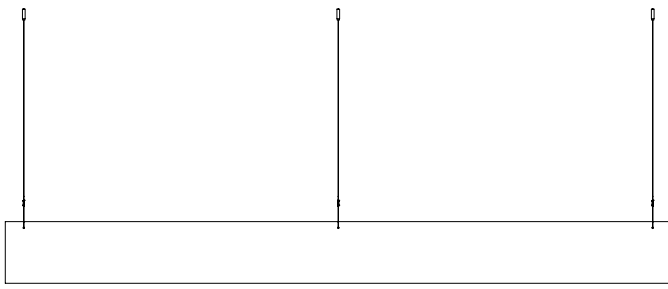

ADJUSTABLE CABLE THROUGH GROMMET

HOOK BAFFLE
(DOES NOT INCLUDE CEILING GRID)

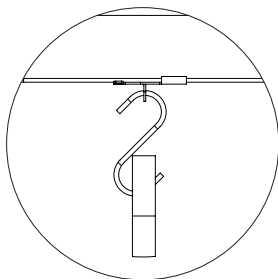
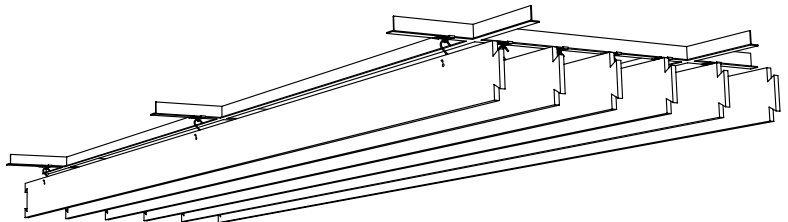
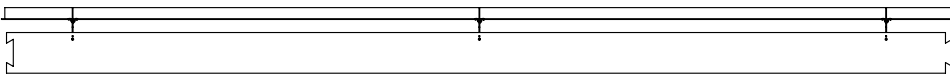

TWIST CLIP LOOP ON CEILING GRID WITH S-HOOK THROUGH ZINTRA

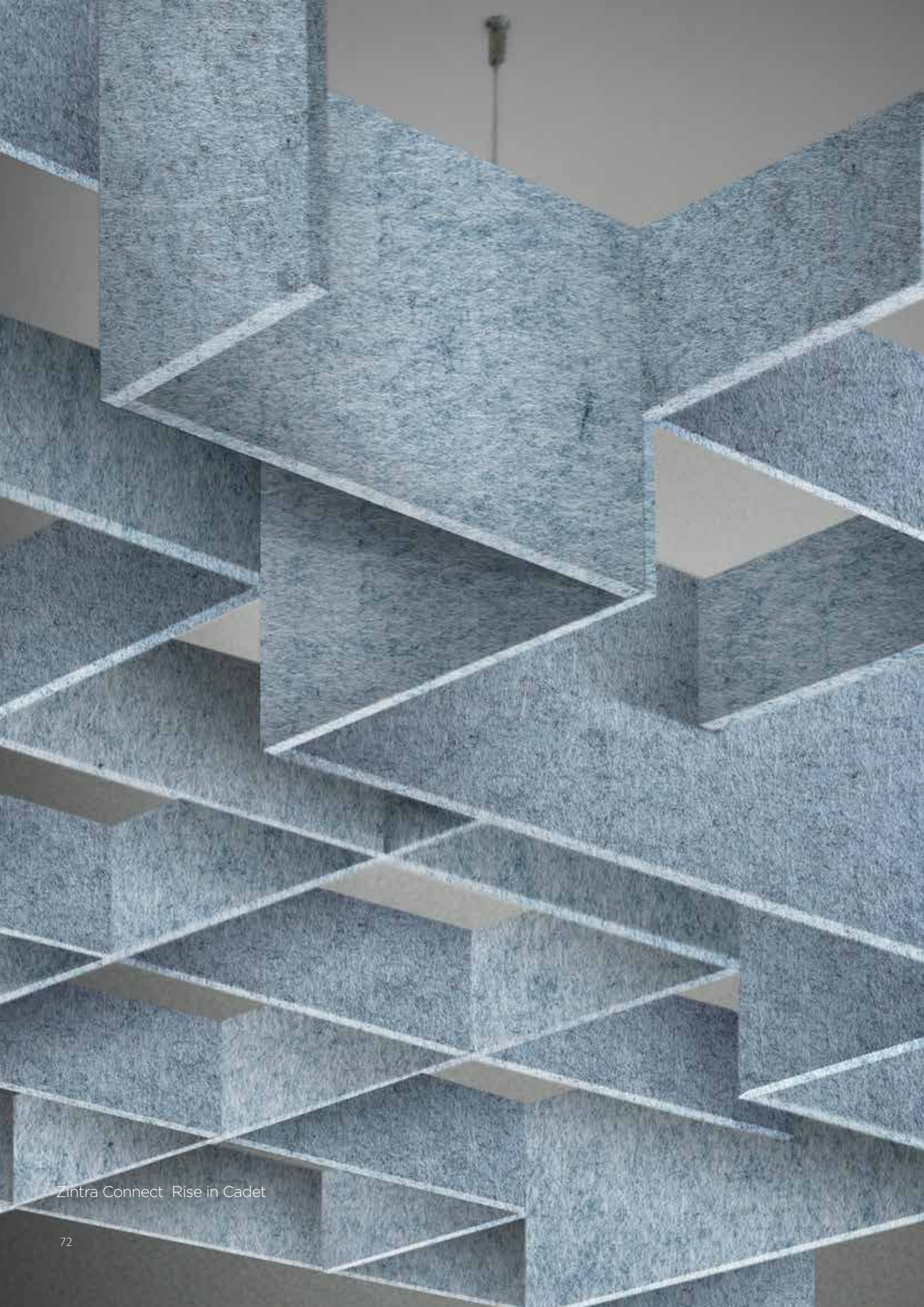

Zintra Connect Rise in Cadet

ZINTRA CONNECT



ADD SCULPTURAL FORM TO YOUR CEILING WITH ZINTRA CONNECT. DESIGNED WITH FULL OR PARTIAL CEILING COVERAGE IN MIND. EACH SYSTEM EASILY FITS TOGETHER AND CONNECTS TO THOSE ADJACENT WITHOUT USING ANY HARDWARE.



Zintra Connect Rise in Chambray

CONNECT SPECIFICATIONS

DIMENSIONS	CIRRUS LOW	3995mm x 2275mm x 190mm [157" x 90" x 7.5"]
	CIRRUS HIGH	3995mm x 2275mm x 300mm [157" x 90" x 11.8"]
	RISE LOW	2770mm x 1220mm x 220mm [109" x 48" x 8.7"]
	RISE HIGH	2770mm x 1220mm x 260mm [109" x 48" x 10.2"]

COLOURS Available in all twenty Zintra 12mm [1/2"] Sheet colours. See page 11.

NRC RATING 0.95. See pages 8-9.

NOTES Only available in Zintra 12mm [1/2"] Sheets.
 Connect includes Adjustable Cable Kits. See page 108 for hardware detail.
 Longer cables, multi-colour and Digital Print available for an additional fee.
 For complete specification and installation information, visit baresque.com.au/brand/zintra



CIRRUS

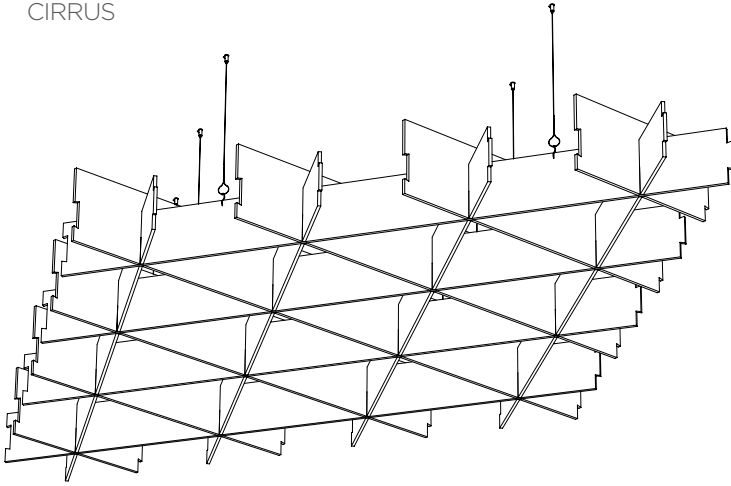

TYPICAL PERSPECTIVE FROM UNDERNEATH

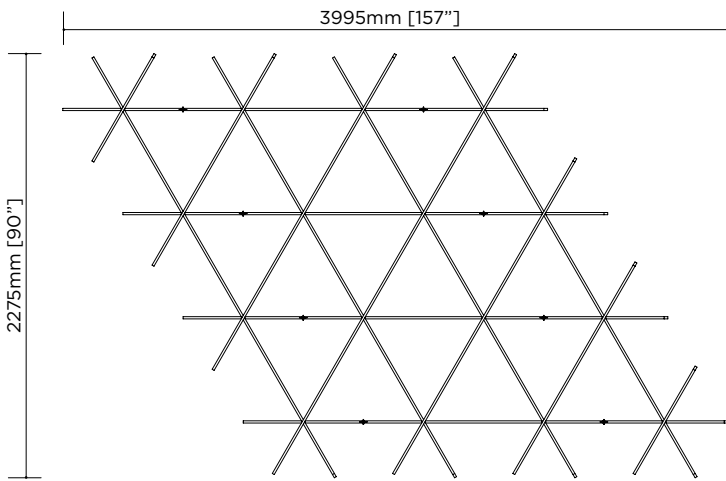

PLAN VIEW

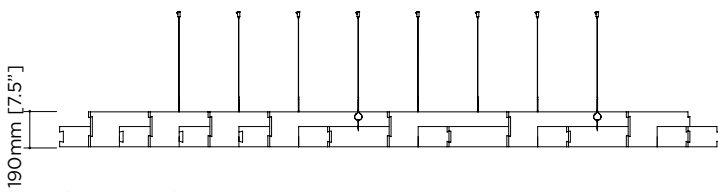

CIRRUS LOW

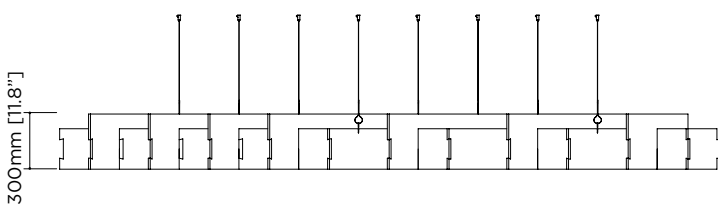

CIRRUS HIGH

RISE

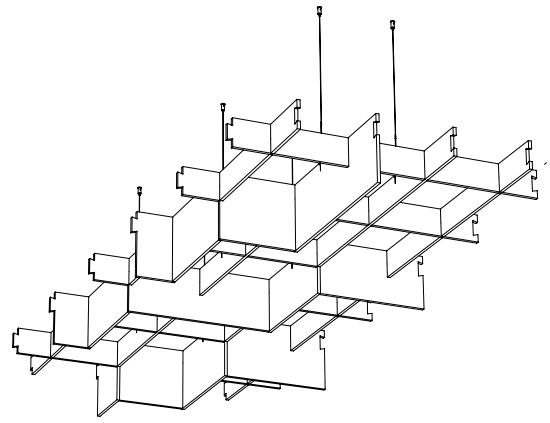

TYPICAL PERSPECTIVE FROM UNDERNEATH

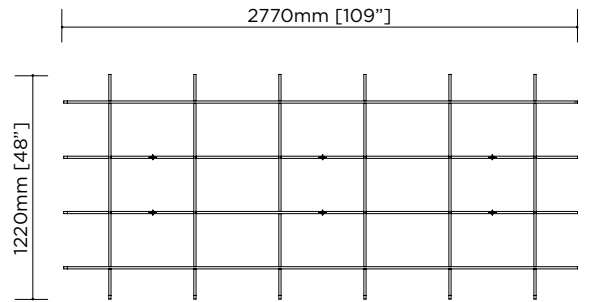

PLAN VIEW

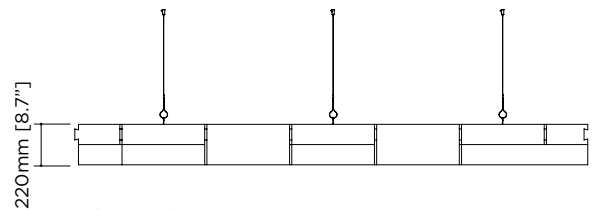

LOW RISE

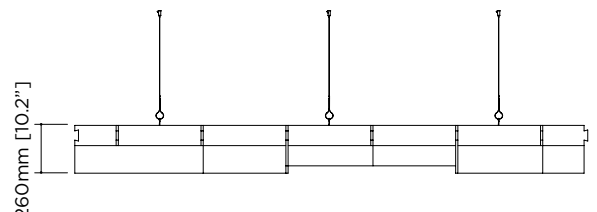

HIGH RISE



Zintra Clouds Blanchard in Mandarin, Sunshine and Pewter

ZINTRA CLOUDS

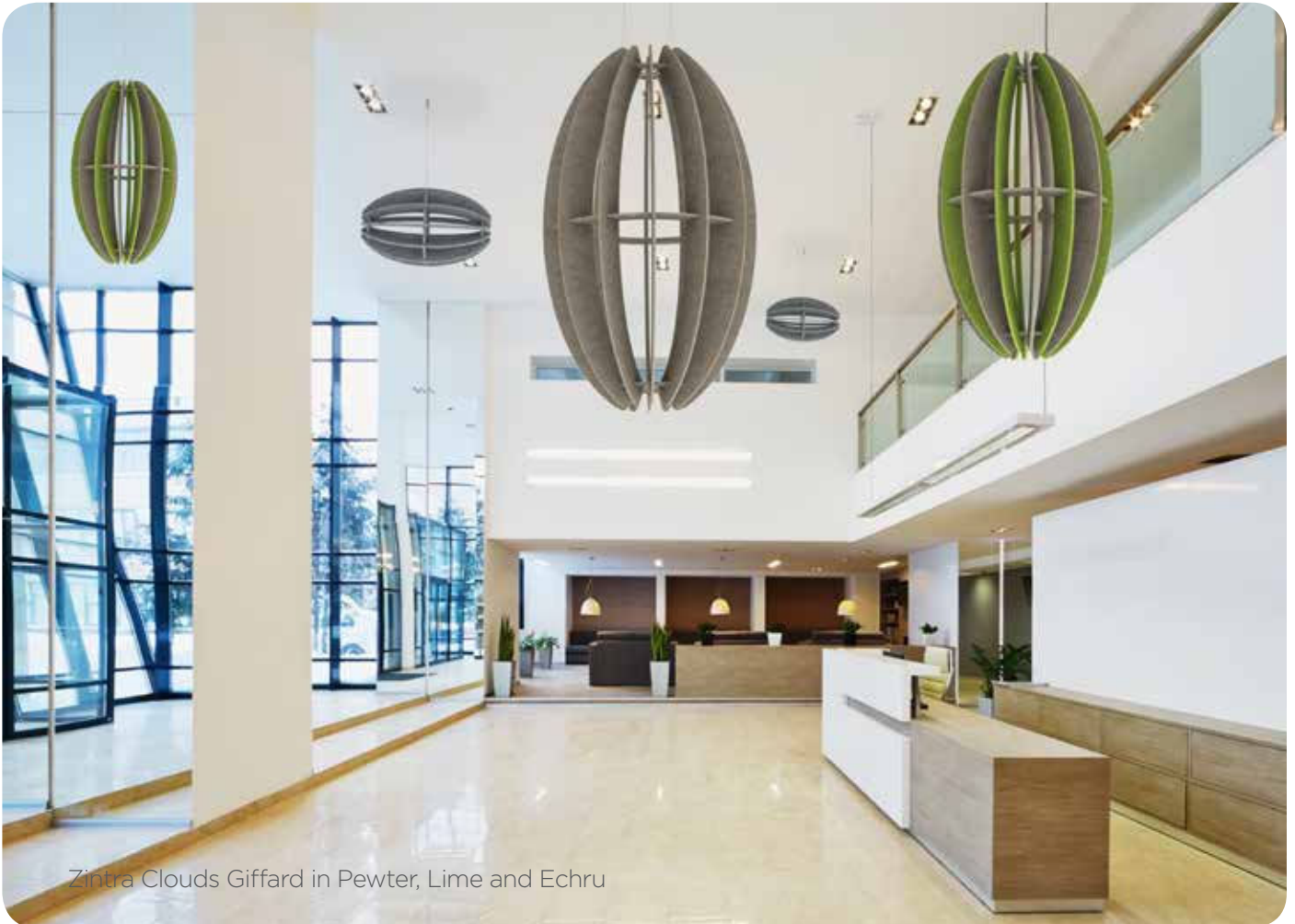

Zintra Clouds Giffard in Pewter, Lime and Echru

ATTENTION GRABBING THREE-DIMENSIONAL DESIGNS IN A VARIETY OF SIZES AND COLOURS ARE A GUARANTEED WAY TO ADD INTEREST WHILE KEEPING NOISE LEVELS DOWN. EACH CLOUD EASILY PRESSURE FITS TOGETHER AND QUICKLY HANGS.



Zintra Stratus Clouds in Smoke

CLOUDS SPECIFICATIONS

DIMENSIONS

See page 81.

COLOURS

Available in all twenty Zintra 12mm [1/2"] Sheet colours. See page 11.

NRC RATING

0.95. See pages 8-9.

NOTES

Only available in Zintra 12mm [1/2"] Sheets.

Clouds include Adjustable Cable Kits. See page 108 for hardware detail.

Longer cables, multi-colour and Digital Print available for an additional fee.

For complete specification and installation information, visit baresque.com.au/brand/zintra



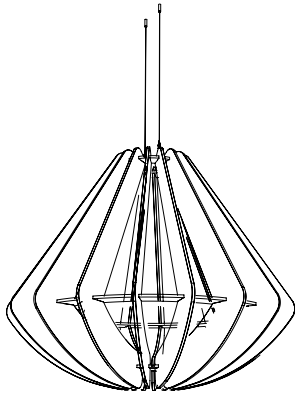

BLANCHARD

1195mm H x 1422 DIA [47" H x 56" DIA]
610mm H x 712mm DIA [24"H x 28" DIA]

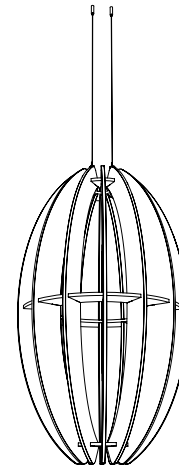

GIFFARD

1803mm x 1066mm [71" x 42"]
1193mm x 685mm [47" x 27"]
584mm x 356mm [23" x 14"]

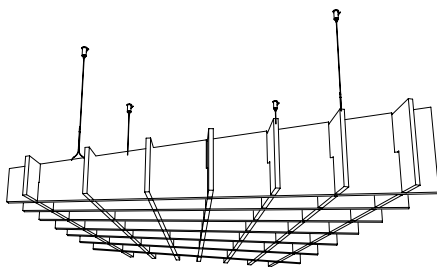

CLOCHETTE

1120mm x 1020 x 230mm [44" x 40" x 9"]

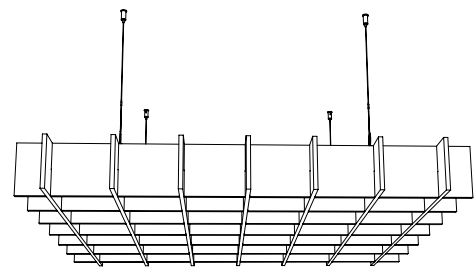

SQUARE

1220mm x 1220mm x 140mm [48" x 48" x 5.5"]
Largest size possible 2750mm x 2750mm [9' x 9']

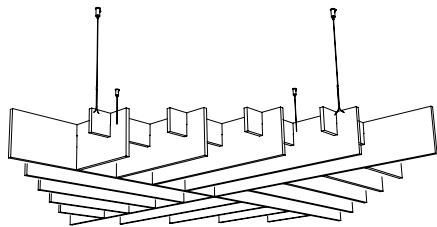

DRANTE

1220mm x 1220mm x 140mm [48" x 48" x 5.5"]
Largest size possible 1830mm x 1830mm [6' x 6']

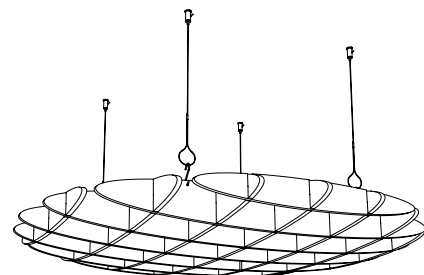

YOOFEO

1220mm DIA x 157mm H [48" DIA x 6.2" H]
Largest size possible 2750mm x 2750mm [9' x 9'] DIA

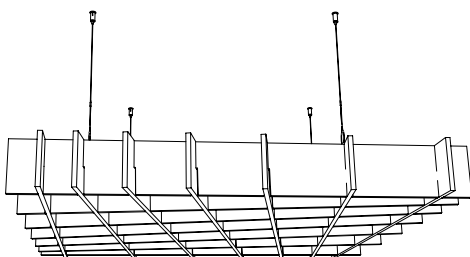

WARP

1220mm x 1220mm x 140mm [48" x 48" x 5.5"]
Largest size possible 2750mm x 2750mm [9' x 9']

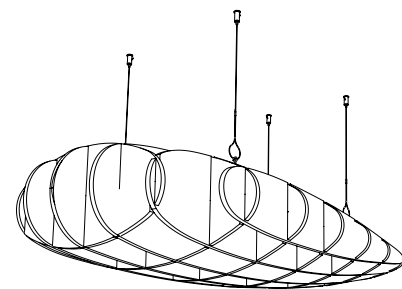

STRATUS

1400mm x 700mm x 292mm [55" x 28" x 12"]



Zintra Shapes Circle in Lime, Pewter and Ivory

ZINTRA SHAPES



Zintra Shapes Square and Triangle in Slate and Echru

USING COMMON GEOMETRIC FORMS, ADD CHARACTER WITH ZINTRA ACOUSTIC SHAPES. INSTALL THEM IN A FOCUSED AREA TO DRAW ATTENTION OR SPREAD THEM THROUGHOUT TO CREATE A PROGRESSIVE DESIGN.



Zintra Shapes Large Rectangle and Square in Linen, Ivory and Ecu

SHAPES SPECIFICATIONS

DIMENSIONS

See page 85.

COLOURS

Available in all five Zintra 24mm [1"] Sheet colours. See page 11.

NRC RATING

0.95. See pages 8-9.

NOTES

Available in Zintra 24mm [1"] Sheets.

Shapes include Adjustable Cable Kits. See page 108 for hardware detail.

Longer cables, multi-colour and Digital Print available for an additional fee.

For complete specification and installation information, visit baresque.com.au/brand/zintra



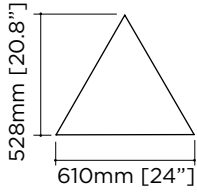

SMALL TRIANGLE

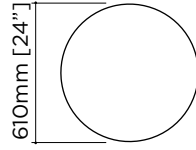

SMALL CIRCLE

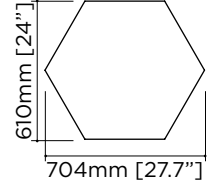

SMALL HEXAGON

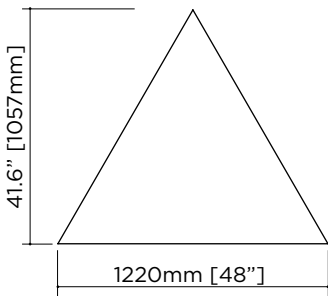

LARGE TRIANGLE

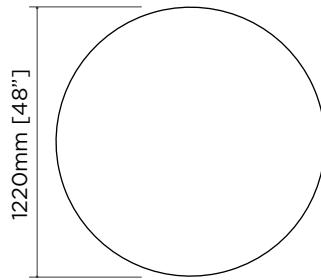

LARGE CIRCLE

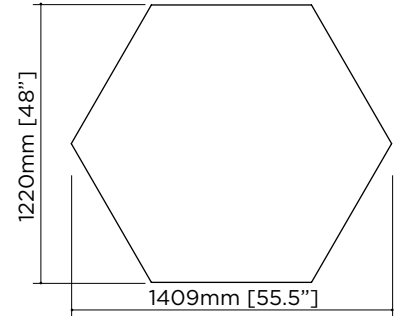

LARGE HEXAGON

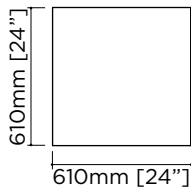

SMALL SQUARE

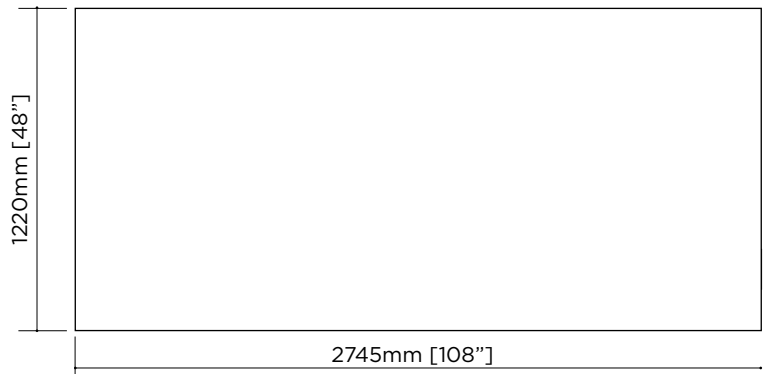

LARGE RECTANGLE

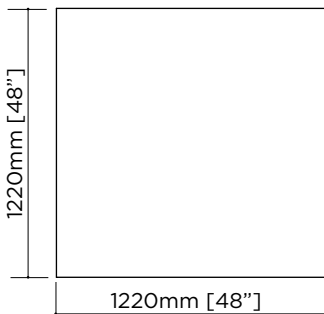

LARGE SQUARE

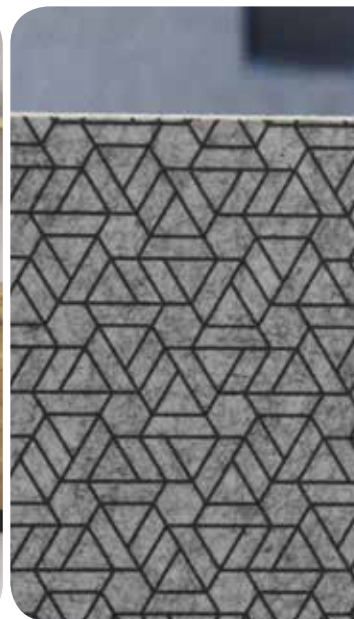

ACCESSORIES





Zintra Concertina Ginkgo in Frost on Smoke

ZINTRA CONCERTINA



Zintra Concertina Bhushan in Silver on Frost, shown with Zintra Concentrina stand

CREATING A WELL-BALANCED ENVIRONMENT HAS NEVER BEEN EASIER THAN WITH ZINTRA CONCERTINA. NO ASSEMBLY IS REQUIRED. JUST UNFOLD, STAND UP AND ADJUST THE PANELS TO THE ANGLE THAT SUITS. WHEN NO LONGER NEEDED, SIMPLY FOLD CONCERTINA FLAT AND STORE AWAY.



Zintra Hex Concertina in Chambray on Ivory

CONCERTINA SPECIFICATIONS

DIMENSIONS	1830mm x 1830mm x 24mm [72" x 72" x 1"]
COLOURS	Available in all twenty Zintra 12mm [1/2"] Sheet colours. See page 11.
NRC RATING	0.95. See pages 8-9.
NOTES	Only available in Zintra 12mm [1/2"] Sheets (two 12mm Sheets laminated together). Pattern may be specified on one side or both. Optional Zintra Concertina stand available. For complete specification and installation information, visit baresque.com.au/brand/zintra



FULLY FOLDED
915mm x 1830mm x 50mm
[3' x 6' x 2"]

90 DEGREES

PERSPECTIVE

TOP VIEW

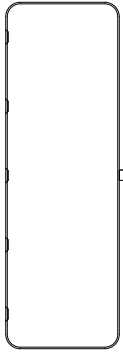

FRONT VIEW

SIDE VIEW



TOP VIEW

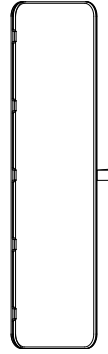
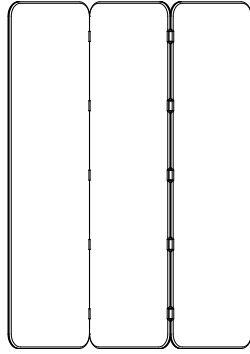

FRONT VIEW

SIDE VIEW

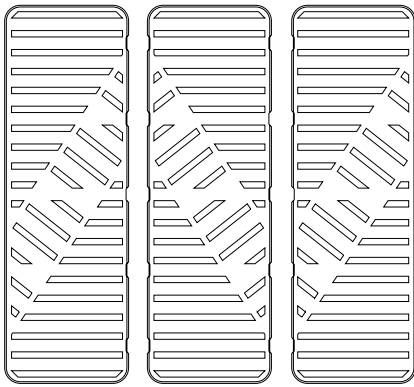
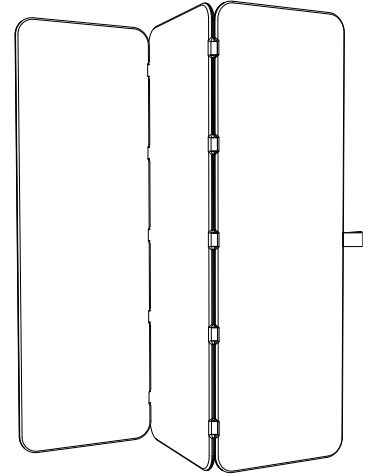

BHUSHAN

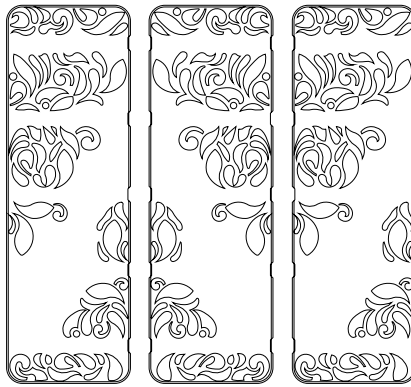

KERALA

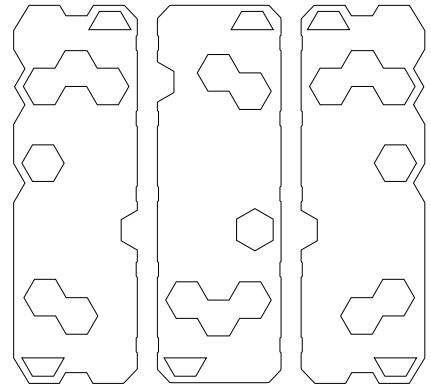

HEX

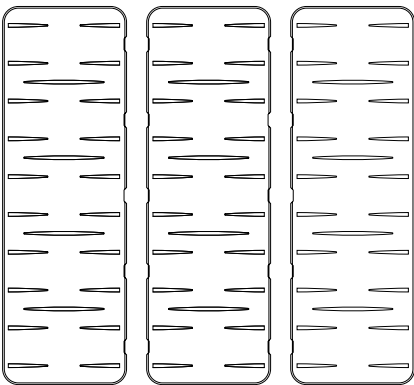

WAMIKA

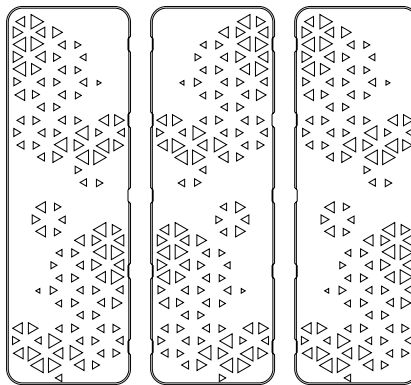

PROSE

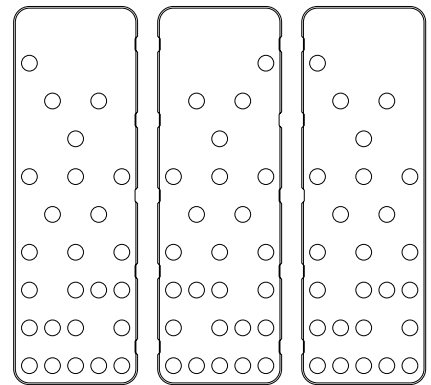

PUNTO

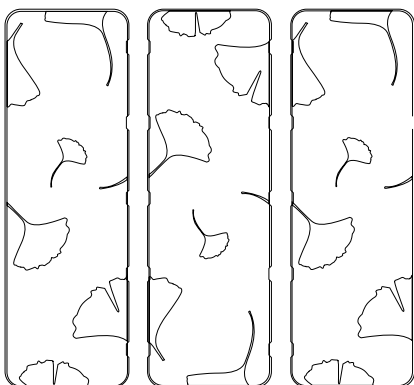

GINKGO

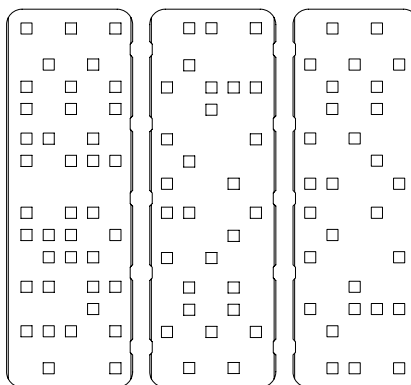

PIXEL



Zintra Desk Wrap in Cadet, shown with Clamshell Clamp Small

ZINTRA DESK WRAP



Zintra Desk Wrap in Pewter, shown with Clamshell Clamp Small

CAREFULLY PLACED SLICE CUTS ALLOW ZINTRA TO BECOME FLEXIBLE AND WRAP AROUND THE CORNERS OF A DESK. WHEN WRAPPED, THE SLICE CUTS REVEAL A DEFINING PATTERN. USE DESK WRAPS AS A SCREEN OR MODESTY PANEL TO ADD PRIVACY AND ACOUSTIC BENEFITS.



Desk Wrap shown with Clamshell Clamp Small

DESK WRAP SPECIFICATIONS

DIMENSIONS	See page 95
COLOURS	Available in all twenty Zintra 12mm [1/2"] Sheet colours. See page 11.
NRC RATING	0.95. See pages 8-9.
HARDWARE FINISH	Clamshell Clamp Small (Desk Wrap Screen) - White L-Bracket (Desk Wrap Modesty) - White
NOTES	Only available in Zintra 12mm [1/2"] Sheets. Zintra Patterns not available. Desk Wrap includes Clamshell Clamp Small or L-Brackets. See page 108 and 110 for hardware detail. For complete specification and installation information, visit baresque.com.au/brand/zintra



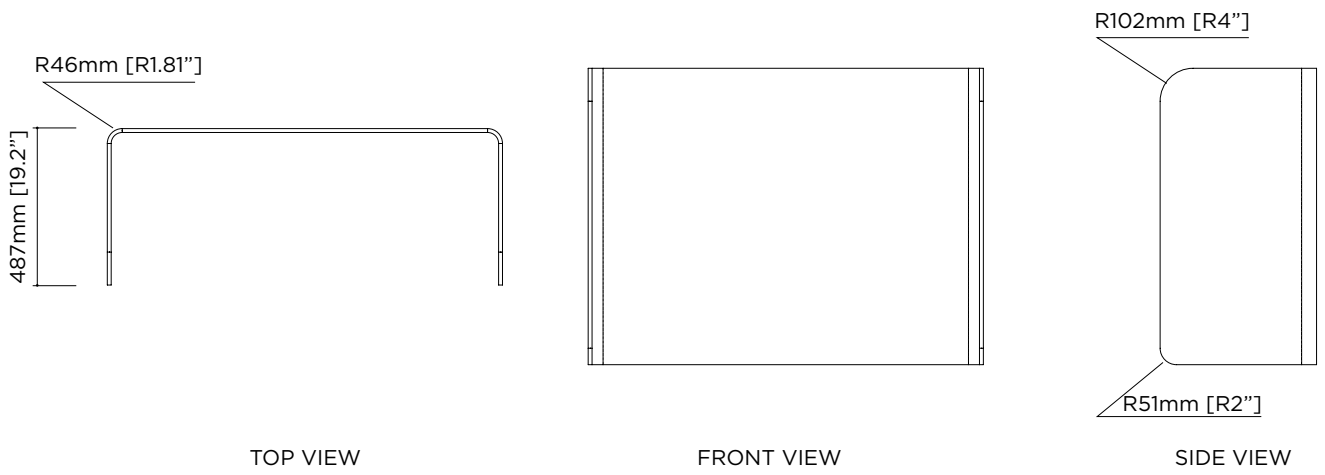

TOP VIEW

FRONT VIEW

SIDE VIEW

DESK WRAP SCREEN

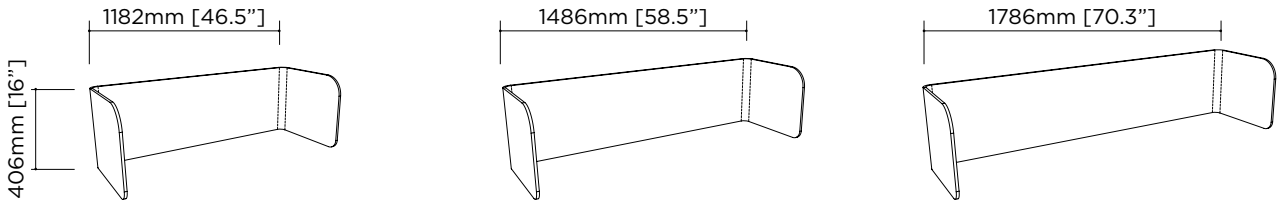

DESK WRAP SCREEN OR MODESTY

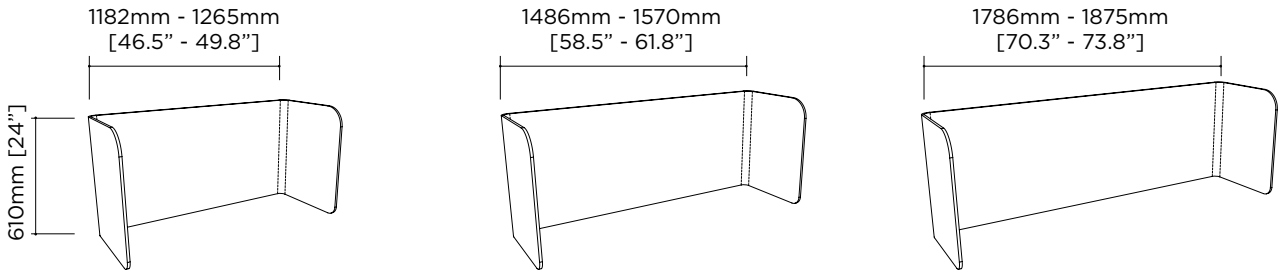

DESK WRAP MODESTY

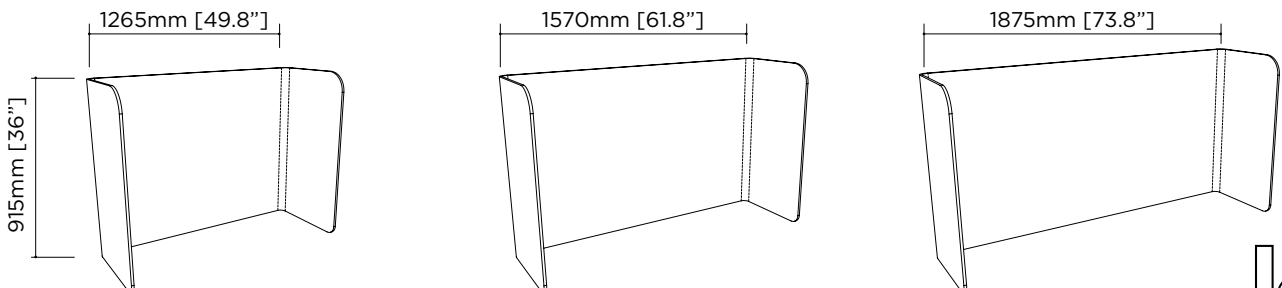



Zintra Desk Dividers Prose in Smoke and Cobalt

ZINTRA DESK DIVIDERS



Zintra Desk Divider Bhushan in Linen and Echru

AN EASY TO USE AND INSTALL SOLUTION WHEN A LITTLE BIT OF PRIVACY IS NEEDED. SIMPLY SLIDE THE DESK DIVIDER OVER THE EDGE OF THE WORK SURFACE AND TIGHTEN THE KNOB. USE DESK DIVIDERS FOR A PERMANENT DIVISION OR AS NEEDED. COMPLETELY CUSTOMIZABLE TO FIT ALMOST ANY WORK SURFACE.



Zintra Desk Divider Pixel in Bark on Linen

DESK DIVIDERS SPECIFICATIONS

DIMENSIONS	610mm x 406mm x 24mm [24" x 16" x 1"] 610mm x 610mm x 24mm [24" x 24" x 1"]
COLOURS	Available in all twenty Zintra 12mm [1/2"] Sheet colours. See page 11.
NRC RATING	0.95. See pages 8-9.
NOTES	Only available in Zintra 12mm [1/2"] Sheets (two 12mm Sheets laminated together). Pattern may be specified on one side or both. Desk Divider Screw included. For complete specification and installation information, visit baresque.com.au/brand/zintra



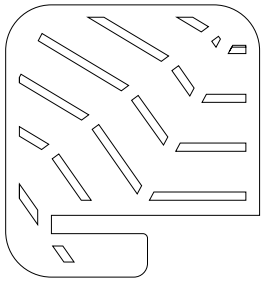
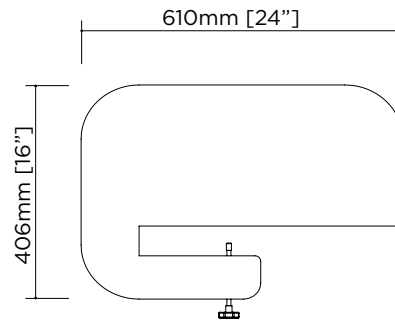
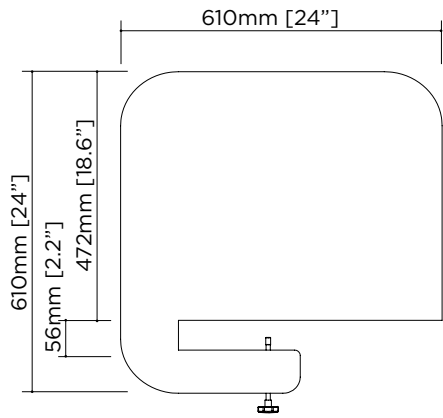

BHUSHAN

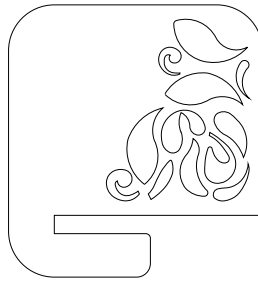

KERALA

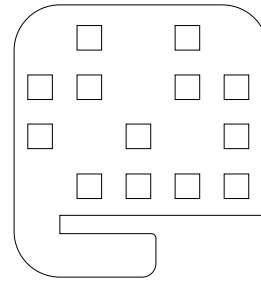

PIXEL

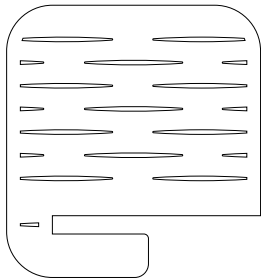

WAMIKA

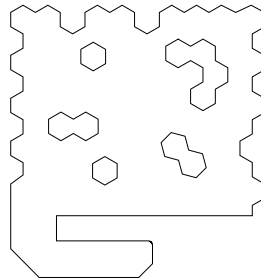

HEX

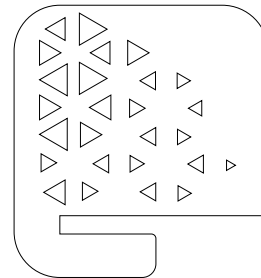

PROSE

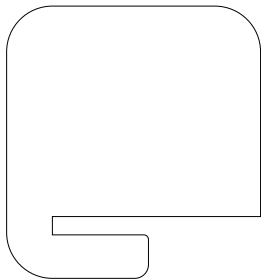

PLAIN

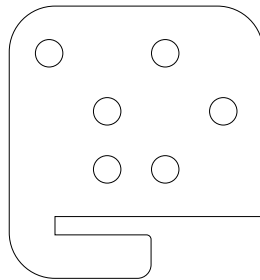

PUNTO

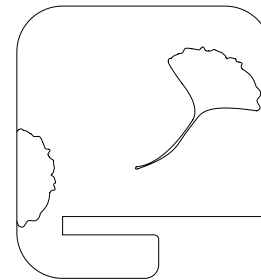

GINKGO



Zintra Desk Screens Prose in Smoke and Cobalt, shown with Clamshell Clamp Large

ZINTRA DESK SCREEN



Zintra Desk Screen Pixel in Chambray on Sky, shown with Clamshell Clamp Large

ZINTRA DESK SCREENS ARE IDEAL FOR OPEN WORK SPACES THAT NEED MORE PRIVACY. THESE SURFACE MOUNTED PARTITIONS SIT SECURELY IN PLACE WHILE CAPTURING UNWANTED NOISE AND ADDING COLOUR AND DESIGN. COMPLETELY CUSTOMIZABLE TO FIT ALMOST ANY WORK SURFACE.



Zintra Desk Screen Punto in Slate on Lime, shown with Clamshell Clamp Large

DESK SCREEN SPECIFICATIONS

DIMENSIONS	610mm x 279mm [24" x 11"]	1220mm x 279mm [48" x 11"]
	610mm x 483mm [24" x 19"]	1220mm x 483mm [48" x 19"]
	1524mm x 279mm [60" x 11"]	1829mm x 279mm [72" x 11"]
	1524mm x 483mm [60" x 19"]	1829mm x 483mm [72" x 19"]
THICKNESS	12mm [1/2"] Single Layer, 24mm [1"] - Two layers x 12mm [1/2"] or 24mm [1"] Monolithic	
COLOURS	Available in all twenty Zintra 12mm [1/2"] and 24mm [1"] Sheet colours. See page 11.	
HARDWARE FINISH	Clamshell Clamp - White	
NRC RATING	0.95. See pages 8-9.	
NOTES	<p>Pattern may be specified on one side or both.</p> <p>Desk Screen includes Clamshell Clamp Small (12mm [1/2"]) or Large (24mm [1"]).</p> <p>See page 108 for hardware detail.</p> <p>For complete specification and installation information, visit baresque.com.au/brand/zintra</p>	



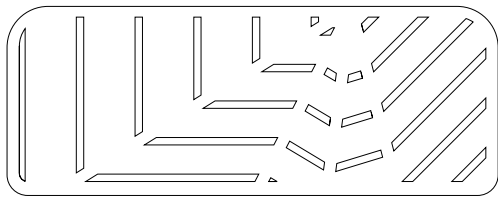
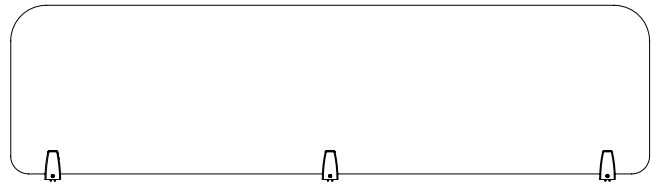
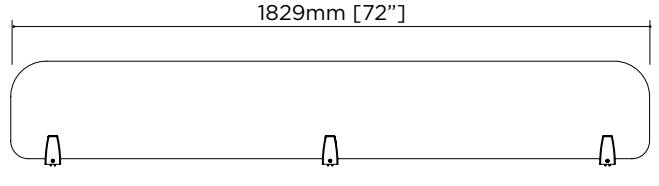
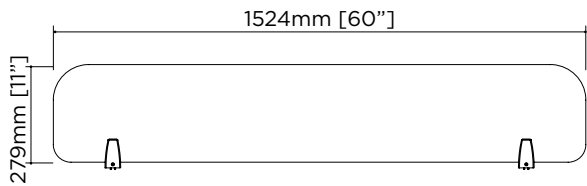
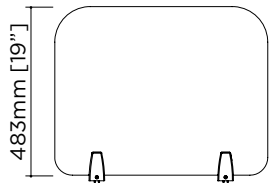
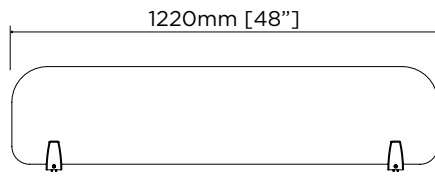
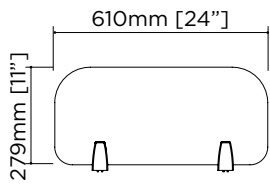

BHUSHAN

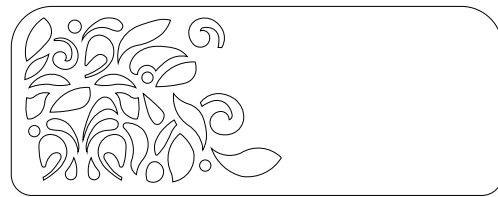

KERALA

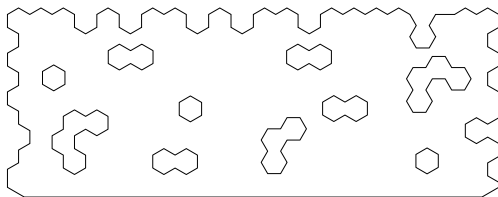

HEX

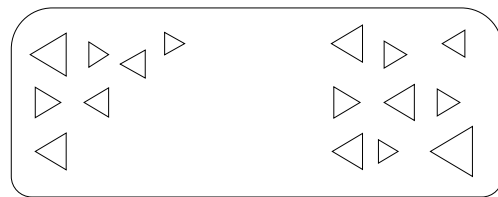

PROSE

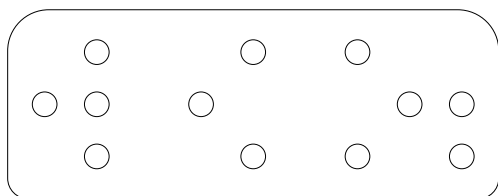

PUNTO

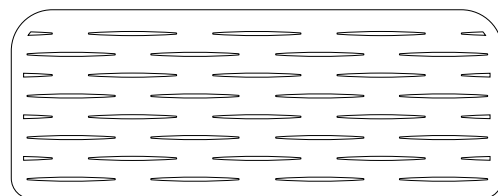

WAMIKA

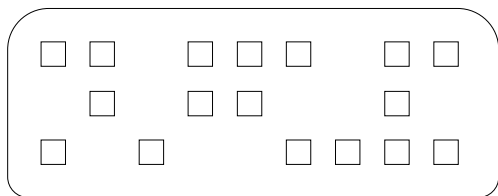

PIXEL

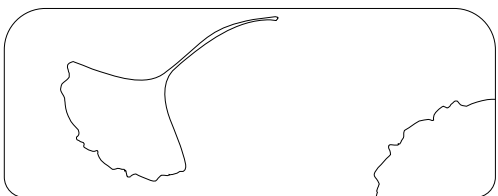

GINKGO



Zintra Desk Modesty Punto in Pebble on Cream, shown with L-Bracket

ZINTRA DESK MODESTY

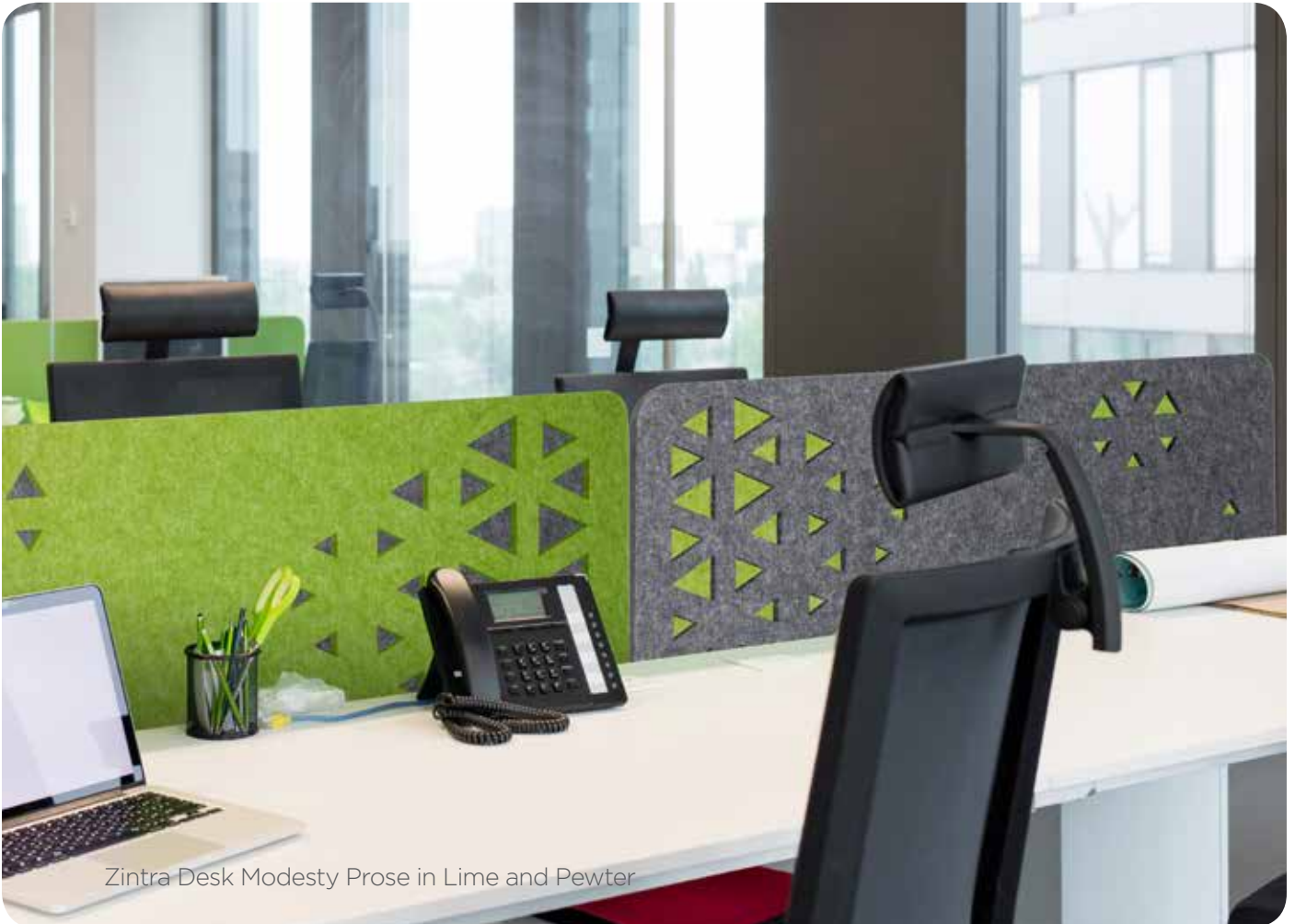

Zintra Desk Modesty Prose in Lime and Pewter

PROVIDE PRIVACY ABOVE AND BELOW THE DESK WITH THESE EDGE MOUNTED SCREENS. AVAILABLE IN A VARIETY OF STANDARD PATTERNS AND SIZES, THE DESK MODESTY IS ALSO COMPLETELY CUSTOMIZABLE.



Zintra Desk Modesty Bhushan in Smoke on Slate

DESK MODESTY SPECIFICATIONS

DIMENSIONS	610mm x 610mm x 24mm [24" x 24" x 1"]	1220mm x 610mm x 24mm [48" x 24" x 1"]
	610mm x 458mm x 24mm [24" x 30" x 1"]	1220mm x 458mm x 24mm [48" x 30" x 1"]
	1524mm x 610mm x 24mm [60" x 24" x 1"]	1829mm x 610mm x 24mm [72" x 24" x 1"]
	1524mm x 762mm x 24mm [60" x 30" x 1"]	1829mm x 762mm x 24mm [72" x 30" x 1"]
THICKNESS	12mm [1/2"] Single Layer, 24mm [1"] - Two layers x 12mm [1/2"] or 24mm [1"] Monolithic	
COLOURS	Available in all twenty Zintra 12mm [1/2"] and five 24mm [1"] Sheet colours. See page 11.	
HARDWARE FINISH	L-Bracket - White	
NRC RATING	0.95. See pages 8-9.	
NOTES	<p>Pattern may be specified on one side or both.</p> <p>Desk Modesty includes L-Brackets. See page 110 for hardware detail.</p> <p>For complete specification and installation information, visit baresque.com.au/brand/zintra</p>	



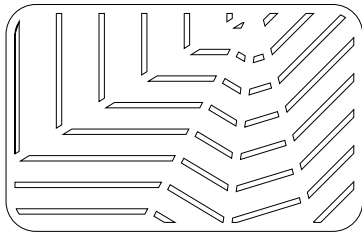
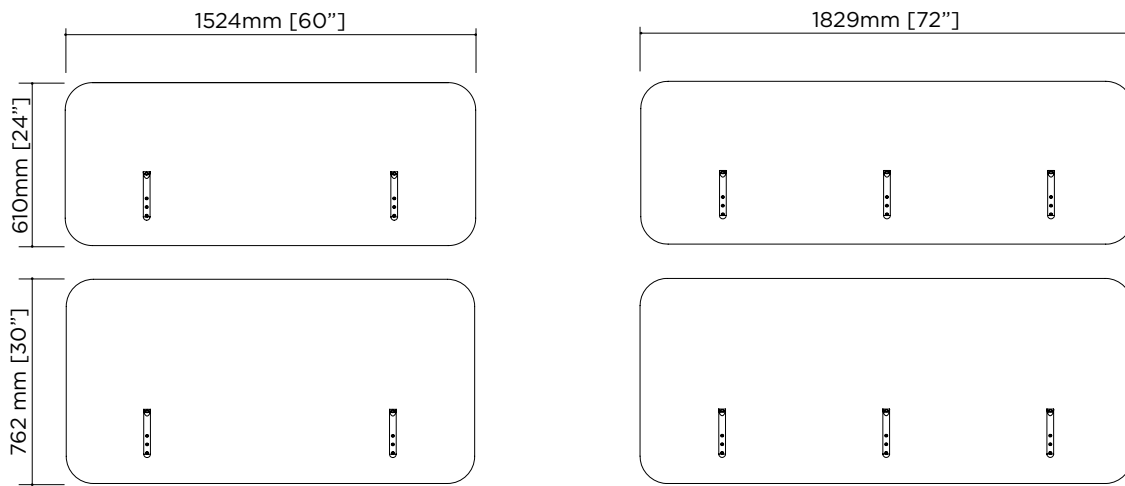
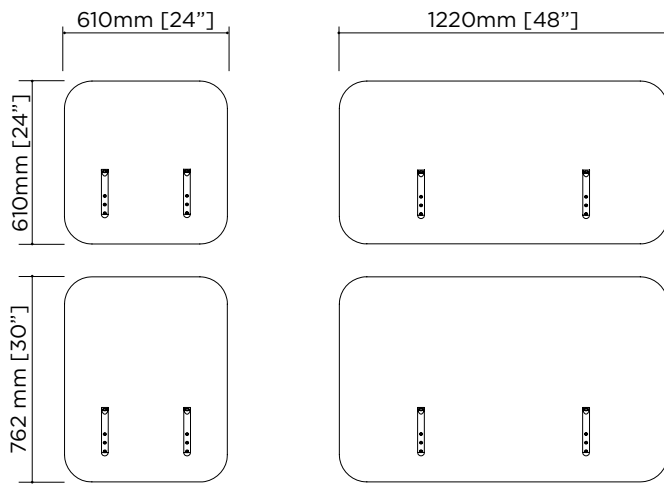

BHUSHAN

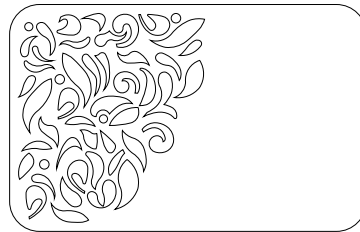

KERALA

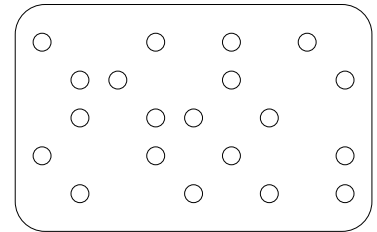

PUNTO

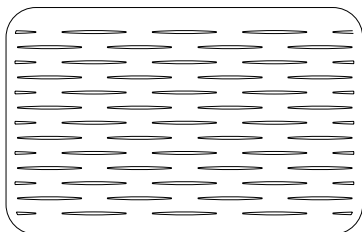

WAMIKA

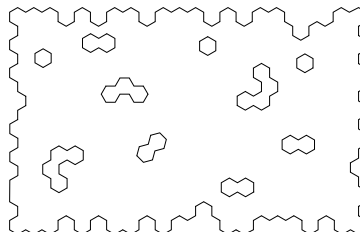

HEX

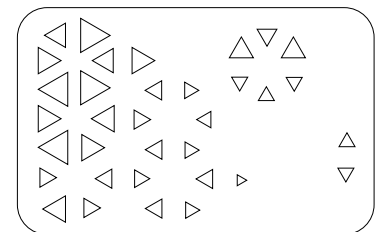

PROSE

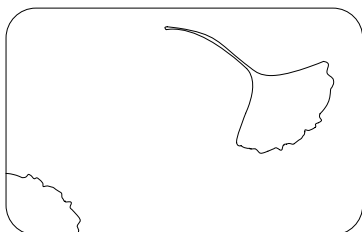

GINKGO

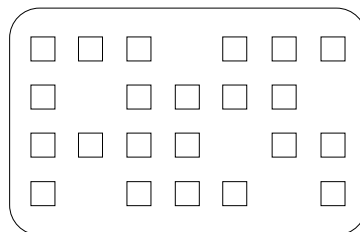

PIXEL



HARDWARE

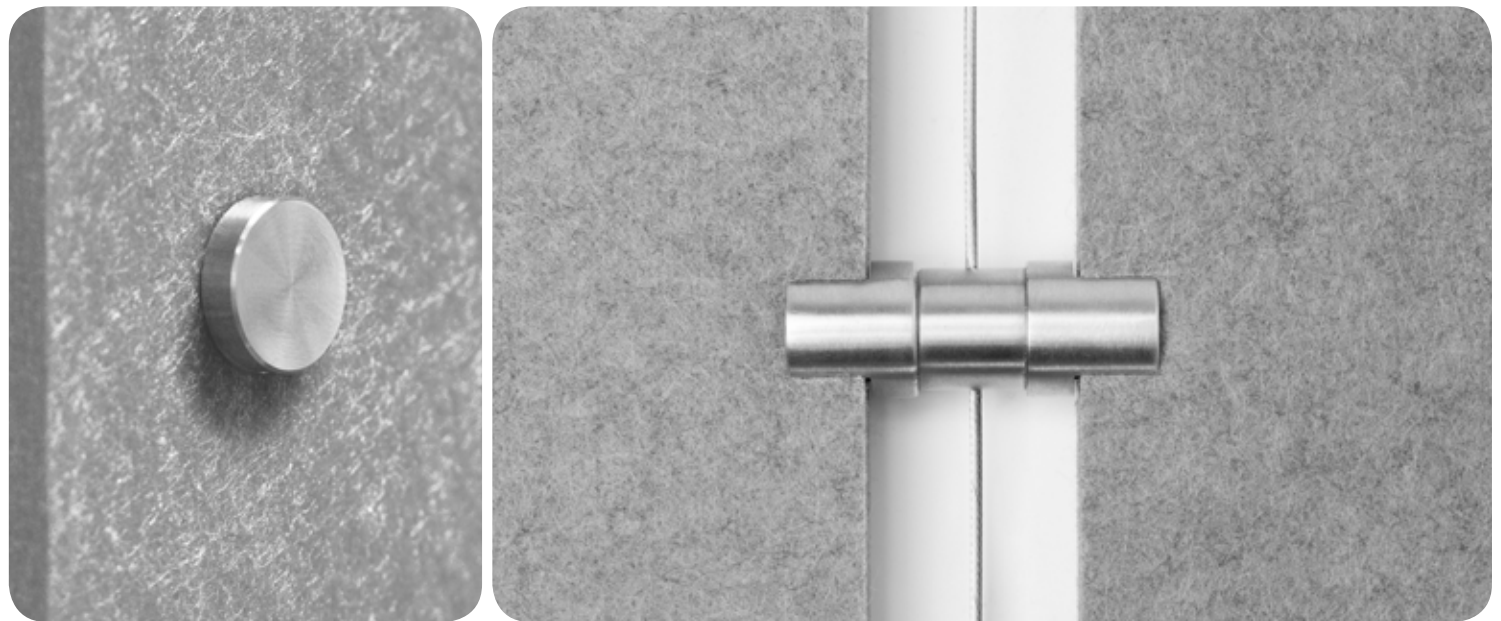
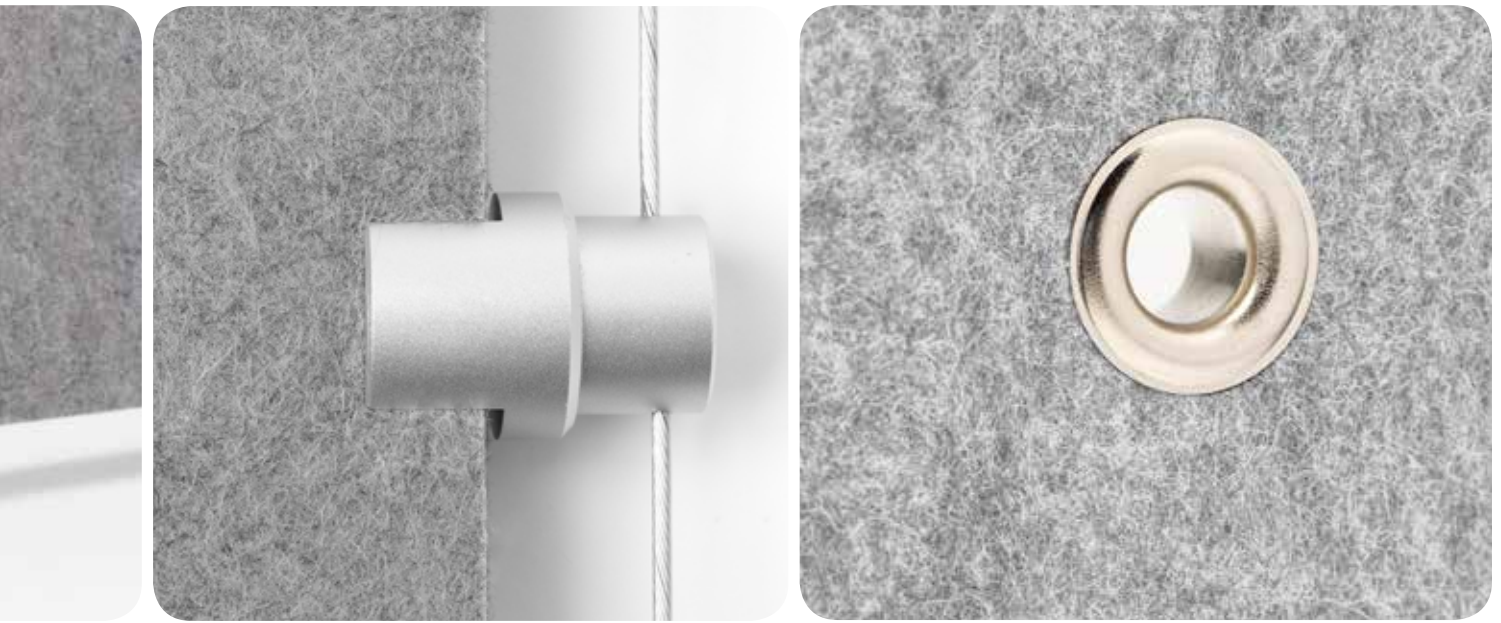



ADJUSTABLE CABLE KIT

FINISH Silver

NOTES Kit includes: 3m Steel cable, barrel fixing, anchor bolt and adjustable toggle.

PRODUCTS Sold as part of Baffles, Clouds, Connect and Shapes



CABLE SIDE GRIPPER DOUBLE

FINISH Clear anodized aluminium

NOTES Compatible with Zintra 12mm [1/2"] Sheets only.

PRODUCTS Available as part of Floor to Ceiling



CABLE SIDE GRIPPER SINGLE

FINISH Clear anodized aluminium

NOTES Compatible with Zintra 12mm [1/2"] Sheets only.

PRODUCTS Available as part of Floor to Ceiling



CABLE STANDOFF

FINISH Clear anodized aluminium body with stainless steel (satin polish) head

NOTES Requires Floor to Ceiling Cable Kit.

PRODUCTS Available as part of Floor to Ceiling



CLAMSHELL CLAMP LARGE

- COLOUR** White
- NOTES** Compatible with Zintra 24mm [1"] thick acoustic solutions.
- PRODUCTS** Available as part of Desk Screen



CLAMSHELL CLAMP SMALL

- COLOUR** White
- NOTES** Compatible with Zintra 12mm [1/2"] thick acoustic solutions.
- PRODUCTS** Available as part of Desk Wrap Screen and Desk Screen



DOUBLE SLIDING TRACK

- DIMENSIONS** 2997mm x 35.6mm x 55.8mm [8' x 1.4" x 2.2"]
- FINISH** Powdercoated aluminium (Black or White)
- NOTES** Custom finishes available for an additional fee.
- PRODUCTS** Available as part of Sliding Screens



FLOOR TO CEILING CABLE KIT

- DIMENSIONS** 4000mm [157"] Cables
- FINISH** Clear anodized aluminium fittings with zinc plate steel cable
- NOTES** Requires Cable Side Gripper (Single or Double) or Cable Standoff
- PRODUCTS** Available as part of Floor To Ceiling



GROMMET

FINISH

Silver or brass

NOTES

Compatible with Zintra 12mm Sheets.

PRODUCTS

Available as part of Individual Baffles



L – BRACKET

FINISH

White

NOTES

Compatible with 24mm thick Zintra acoustic solutions.

PRODUCTS

Available as part of Desk Wrap Modesty or Desk Modesty



ROLLERS

FINISH

Powdercoat to match Double Sliding Track

NOTES

Minimum of (2) roller kit required for panels 1220mm [48"] wide or less,
(3) roller kit required for panels wider than 1220mm [48"].
Requires Double Sliding Track.
Kit includes Rollers and Fixing Plates.

PRODUCTS

Available as part of Sliding Screens



S-HOOK

FINISH

Silver

NOTES

Requires Grommet with either Twist Clip - Loop or Twist Clip - Swivel.

PRODUCTS

Available as part of Individual Baffles



STANDOFF - 30mm

- FINISH** Satin polish stainless steel
NOTES Supplied with Lag Bolt
PRODUCTS Available as part of Floor to Ceiling



STANDOFF - 50mm

- FINISH** Satin polish stainless steel
NOTES Supplied with Lag Bolt
PRODUCTS Available as part of Floor to Ceiling



SQUARE TUBE 25mm x 25mm [1" X 1"]

- DIMENSIONS** 25mm x 25mm x 2794mm [1" x 1" x 9'2"]
FINISH Powdercoat aluminium Black or White
NOTES Custom finishes available for an additional fee.
PRODUCTS Available as part of Blades and Baffles



TWIST CLIP - LOOP

- COLOURS** White
NOTES Compatible with 25mm [1"] ceiling grid profiles.
Requires S-Hook
PRODUCTS Available as part of Individual Baffles



TWIST CLIP - SWIVEL

- COLOURS** Clear
NOTES Compatible with 25mm [1"] ceiling grid profiles.
Requires S-Hook
PRODUCTS Available as part of Individual Baffles

zintra®



baresque

53-55 whiting st artarmon
nsw 2064 australia

e info@baresque.com.au | p 1300 306 399 | www.baresque.com.au

For complete specification and installation information, visit baresque.com.au/brand/zintra